

# System for Monitoring Sap Flow in Trees for Better Management of Available Irrigation Water.

Gamero-Inda E.<sup>1</sup>, García-Moreno L.I.<sup>2</sup>, Godínez-García F.J.<sup>1</sup>, Martínez-Rivera J.A.<sup>1</sup>, Guerrero-Rivera R.<sup>1</sup>, Ortíz-Medina J<sup>1</sup>.

<sup>1</sup> Tecnológico Nacional de México TECNM/IT Durango,  
Professors, MSc. in Engineering, Durango, México.

<sup>2</sup> TECNM/IT Durango, Student, MSc. in Engineering, Durango, México.

\*\*\*

**Abstract** – *The present work shows the design and assembly of a sap flow monitoring device to perform continuous readings in trees, based on the “Heat Field Deformation” (HFD) method, through the use of “easy to get” electronic systems and circuits. Additionally, we obtained a piece of software that enhances the device and makes it easy to switch to different types of trees (including fruit trees). The novelty of this proposal is to offer small and medium producers a technological, simple, and economical way to achieve a better and sustainable use of available irrigation water.*

**Key words:** *Agroindustry, Sap Flow Measuring, Precision Irrigation, Water Management.*

## 1. INTRODUCTION

This project responds to a felt need for better and responsible water consumption when used for irrigation purposes, with great attention to irrigation of an orchard of fruit trees. This, is especially true in the Mexican state of Durango, where the cultivation of apple trees is a significant source of revenue for the small and medium producers in the municipality of Canatlán, Durango, México.

Knowing sap flow is a unique tool for achieving precision irrigation in apple trees. Understanding the water needs of apple trees is essential to achieve optimal and high-quality production. Measuring the water status of trees provides direct information on irrigation limitations, which, combined with monitoring sap flow, allows the relationship between climate and soil water to be adjusted to maintain an appropriate balance (Ferreira, et. al 2102). Precision irrigation offers several benefits, including greater efficiency in water use, reduction in production costs, and an enhancement in the quality of the final product (Siddiqi, et. al 2021). Therefore, monitoring sap flow can, significantly improve the consumption of irrigation water in apple trees orchards.

Sap flow measuring is a technique that allows you to, among other things, manage water use by trees. This technique, is commonly used to determine the water needs of crops. Sap flow sensors allow for accurate, real-time measurement of tree water consumption. Sensor technology has advanced significantly in recent years, allowing us to obtain greater

accuracy in sap flow measurements (Davis, et. al 2012). The most widely used technique to measure sap flow is the heat technique (Nadezhdina, 2018). Sap flow sensors are easy to install and can provide valuable information for precision irrigation monitoring in apple trees since using this information, the quantity of irrigation water can control fruit size or maximize it in cultivars with larger fruits or minimize it in cultivars with smaller fruits

Much better use of irrigation water in agriculture is a grave matter of discussion since climate change has affected some human activities, including agriculture (Chartzoulakis, et. al 2015). The combination of increased temperatures, changes in total annual rainfall, and population growth, is leading to longer periods of drought, and consequently, plants are exposed to greater stress. In the face of this challenge, digital technologies, such as the Internet of Things (IoT), can collect a good amount of data that can help producers facilitate decision-making and present themselves as an ally for the correct determination, quantity and, application of irrigation water.

## 1.2 Monitoring System.

The principal measurement variable is temperature, measured digitally using the 1-Wire Protocol since the devices with this protocol represent a great advantage for a portable system with more than one sensor. Since here it is important to reduce space and the number of connections for the circuits. The system uses point-to-point communication where one of the nodes is responsible for collecting the data that in turn, is transmitted through radio frequency communication modules. The receiving node has a Wi-Fi module with which it is possible to upload this data to the cloud for subsequent analysis and visualization.

## 1.3 Heat Field Deformation Method

In simple terms, the HFD method (Heat Field Deformation Method), as its name indicates, is based on the measurement of the heat field deformation around a needle-shaped linear heater inserted in a radial direction into the trunk stem of the tree. If we could see the heat field from the front (Figure 1), it would appear as a symmetrical ellipse, due to the different thermal conductivities of the trunk fibers in the

axial and tangential directions under zero flow conditions. Applying heat utilizing the linear heater, we can obtain a deformation in the shape of the ellipsoid of the heat field under the influence of the sap flow. The stem must be considered a complex material composed of xylem solid substance, water, and air. The idea of the method arose circa 1989 when sap flow rate, sensors based on HFD method, were applied to measure sap flow in plants (Nadezhkina, et. al, 1989). Then, in 2018 a group of researchers use a related method (Green, et. al, 2018) to apple trees. The sap flow can significantly change the heat field by lengthening the ellipse, as shown in Figure 1

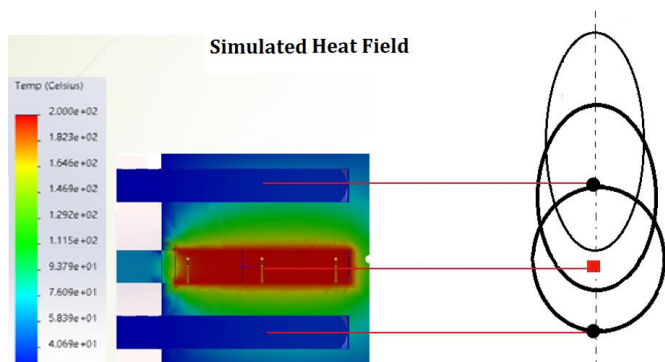

Figure 1: Simulated Heat Field.

### 1.4 Measurement Principle.

The HFD technique is a thermodynamic method based on measuring symmetrically the sapwood differential temperature up and down axially ( $dTs$ ) and asymmetrically ( $dTas$ ) tangentially or laterally around a linear heater (Nadezhkina, 2018). The heater continuously heats the sapwood establishing an elliptical heat field under zero flow conditions. Figure 2, a) shows graphically the measurement principle with a possible sensor and heater cartridge array, and b) shows the possible distances between the sensors and the heater cartridge.

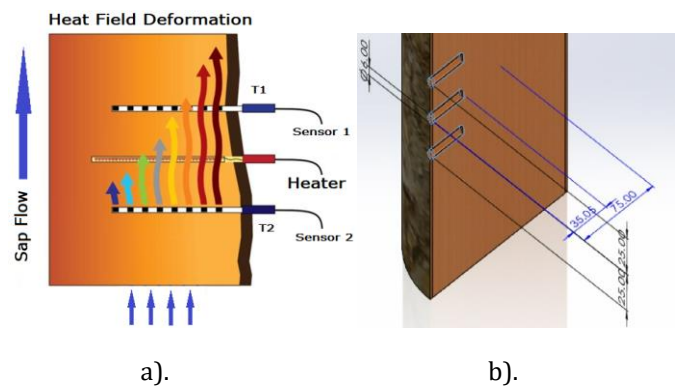

Figure 2: a). Possible sensors and heater array, (ictinternational.kr, 2020), b). Possible sensor position in the sapwood.

The symmetrical temperature difference allows the measurement of bidirectional (up and down) sap flow and even minimum flows, while the asymmetrical temperature difference is mainly responsible for the magnitude of medium and high sap flows. In this project, we only use the symmetrical temperature difference. Using the ratio of measured temperature differences ( $K$ ), applying corrections for local conditions at each measurement point, and utilizing adjustable  $K$  values, common characteristics of the medium, such as variable components, natural temperature gradients, and wound effects are identified and can be used to calculate sap flow. The value of  $K$  is equal to the absolute value of  $dTs$  under zero flow conditions. Under flow conditions, the  $K$  parameter can be accurately estimated, using linear regression analysis

## 2. BASIC DESIGN OF THE DEVICE.

In this section, we will explain the basic design of the device and the components utilized to synthesize the system.

### 2.1 Description of the components.

The measurement module consists of an STM 32F411 Core-64® microcontroller with a 32-bit ARM Cortex-M4® Microcontroller connected to two DS18B20 digital sensors powered at 5 volts, a heating cartridge fed by an MOS power module bias by an independent power supply. On the other hand, we have an NRF24l01® module responsible for point-to-point wireless radio frequency communication directly to the receiver node. Then, the receiver uploads the data to the cloud for subsequent processing.

Figure 3 shows the transmitting module prototype that includes the two temperature sensors, the heating cartridge, the microcontroller, the RF module, and the other necessary and complementary elements for the transmitting module. Figure 4 shows the receiving module with the RF element.

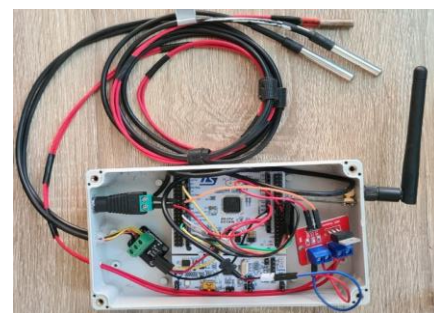

Figure 3: Transmitting Module Prototype.

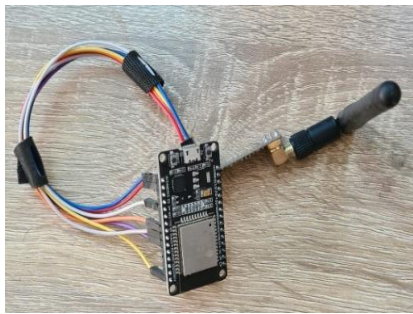

Figure 4: Receiving Module Prototype.

### 2.2 Preliminary Measurements of the system.

Once installed the transmitting module and the interface of the receiver with the computer were connected for the functional tests, and a simple three-stage experiment was developed, introducing the sensors into a porous polyurethane foam (shaped as a brick) capable of absorbing water. These tests were carried out by placing the sensors at a distance of one centimeter from above and below the heating element placed in the middle of the foam brick.

The dimensions of the brick are 23 centimeters high and a base of 10x10 centimeters. In the first stage, the green area shows the sensors' response without wetting the foam. In the second stage, a flow of water simulating the sap flow was poured from the top, and the response of the sensors are in the blue area. In the third stage, the sensors were removed from the foam brick and placed at ambient temperature (pink area). Figure 5 shows the complete results of the preliminary tests and the location of the sensors and the heater.

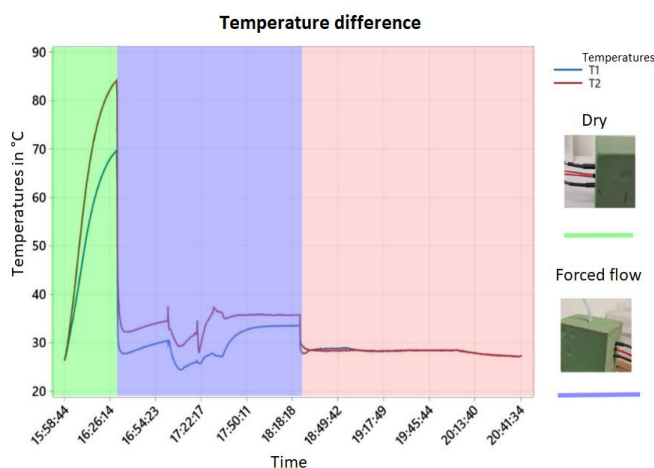

Figure 5: Preliminary measurements of the system.

With these results, we obtained some conclusions about the performance of the measurement of the implemented system; first, it is possible to differentiate T1 and T2 from each other, which is good since one of the objectives is to establish a temperature differential between the sensors. Second, as a consequence of the latter, the obtained

measurements can be utilized in the programmed algorithm to obtain a numerical value of the sap flow in the tree of interest.

### 2.3 Programming the Measurement System

The code loaded into the sending data device was developed in the STW32® programming environment, and a setting was created for sending data to a data array defined for the two measurements (T1 and T2), which come from the temperature sensors placed in the sapwood of the corresponding tree. It is possible to read each sensor connected to the same connection due to the 1-Wire communication protocol, and it is possible to access the information of each sensor thanks to our own "wire" library to adjust the measurement of each sensor and then transmit the measurement data to the receiver to be load to the platform.

In Figure 5, you can see in the pink section how, at room temperature T1 and T2 temperatures are balanced, indicating that each sensor had almost the same measurement value to reduce the variation and thus reduce the measurement error. To write the receiver code, we utilize a similar procedure used for data sending, load the libraries for the integrated Wi-Fi, the RF communication with the receiving antenna, and the network credentials.

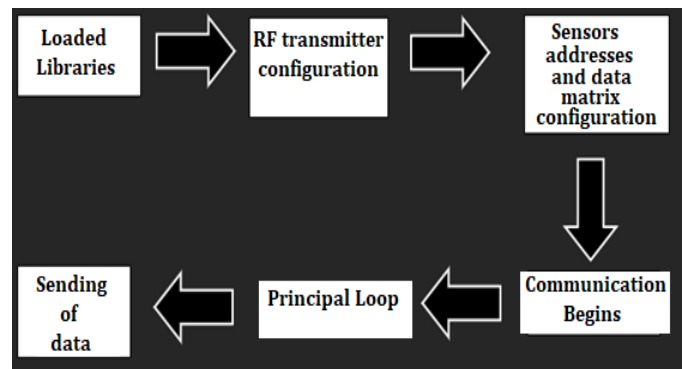

Figure 6: Flow Diagram of Transmitting Device.

Figure 6 shows the flow diagram for sending the data to the receiving node.

Using the SSID (Service Set Identifier) address and network password, the data array parameters were configured for the reception, along with the sensor and the receiving antenna configurations; then, the main cycle begins. Upon receiving data from the transmitter, the incoming data are written to the serial port and finally uploaded to the cloud platform. Thingspeak™ platform performs to visualize the information. The flow diagram of the receiving node is in Figure 7, and it shows the logic for data uploading to the cloud and server for further processing.

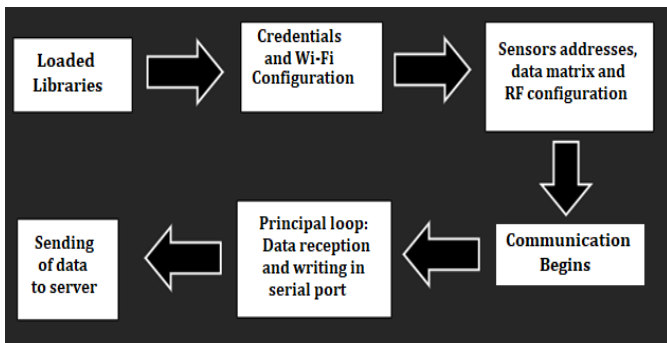

Figure 7: Flow Diagram of Receiving Device

### 2.4 Preliminary Tests of the System.

The first tests were to verify the performance of the point-to-point network and Wi-Fi communication configuration and the correct operation of the platform in the cloud. For the test, the emitter module was installed at a height of 2 meters from the base of the tree with holes of 5 mm. in diameter, 30 mm. deep, and 25 mm. distance between the heating cartridge and both sensors. The first part of the communication occurs in the radio frequency connection of the RF transmitter, configuring the addresses of the sender and receiver with the same key to receive the data; all these were stored in the microprocessor.



Figure 8. Sample Graphs of Measured Temperatures.

In the case of the receiver, we configured the network data, the access key, and the user channel, which then permits the information to be uploaded to the platform for graphical viewing. Figure 8 shows two sample graphs of measured temperature from the Thingspeak™ platform. Using the Wi-Fi connection, data is uploaded and stored to form the measurement database.

### 3. PERFORMANCE TESTS OF THE SYSTEM.

In this section, we will explain the results obtained with the sap flow measurement prototype.

#### 3.1. Initial Measurements of the System.

The sap flow measurement system needs to be tested, so the prototype was placed two meters high in the trunk of a tree,

as shown in Figure 9. Continuous temperature measurement for the first performance test in an alive specimen consists of temperature measurement for four days in an eucalyptus tree. We chose this tree for its thin bark and easy access to the sapwood, in addition to the fact that these types of trees have a high sap flow.



Figure 9. Placement of Sensors and Circuitry in eucalyptus tree.

During two days constant heat was applied to the trunk, and corresponding measurements were registered. In the following two days, the heat was suspended, and measured temperatures were registered and displayed in the graph in Figure 10.

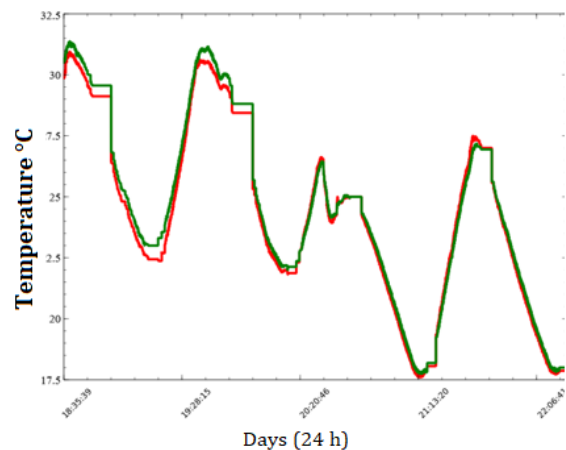

Figure 10. Temperatures Measured in Four Days Time Lapse.

For the next temperature measurements, we placed the system in a younger and different tree; It was an apple tree. The measurements were taken between 10:00 and 18:00 hours, and as can be seen in Figure 11, there is a tendency for temperature to raise during the day and a decreasing one as the afternoon falls.

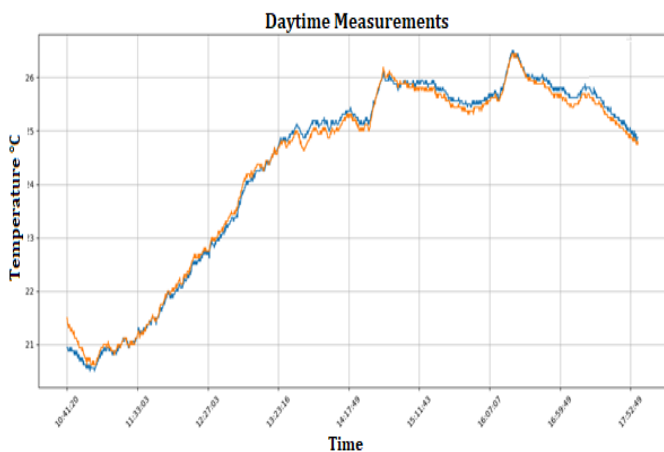

Figure 11. Measurement tests in the daytime.

### 3.2. Sap Flow Determination

The following sap flow graphs were obtained by applying equation (1) seen in previous works and using the data taken in each measurement. Equation (1), taken from Nadezhdina (2018), and whose parameters were explained in section 1.4 and programmed in Python code, is utilized to obtain the value of sap flow graphically. This equation is the basis for the substitution of data for different types of trees within the programming of the interface, and where the data is adjusted depending on the variables of interest, such as type of tree, depth, the distance between the sensors, and the diameter of the analyzed tree.

$$q_1 = 3600D_{nom} \frac{(K + dT_{s-a})}{dT_{ax}} \cdot \frac{z_{ax}}{z_{tg}} \quad (1)$$

The latter is done because, when calculating sap flow in the algorithm, it is possible to avoid some erroneous results since data may not be changed, and the same parameters were used for another measurement. If the scenario is changed, it is also necessary to change the parameters in the measurement system.

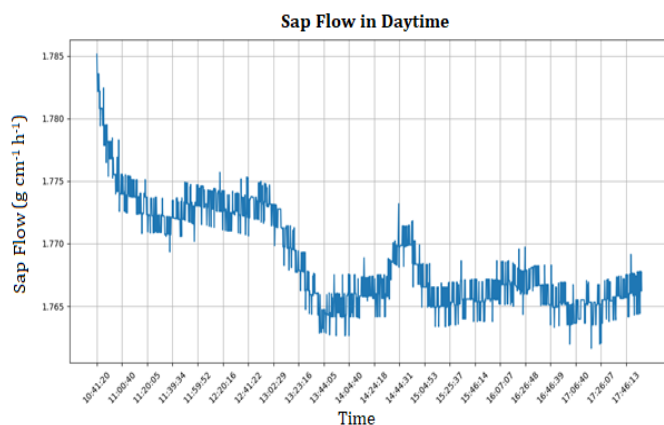

Figure 12. Measured Sap Flow in the daytime.

Figure 12 shows daytime sap flow per section of a pine tree test specimen, and we can see that the measured sap flow tendency is according to the typical behavior in a tree, that says sap flow in the morning is less than that at night, and the obtained numerical value is realistic for that kind of tree.

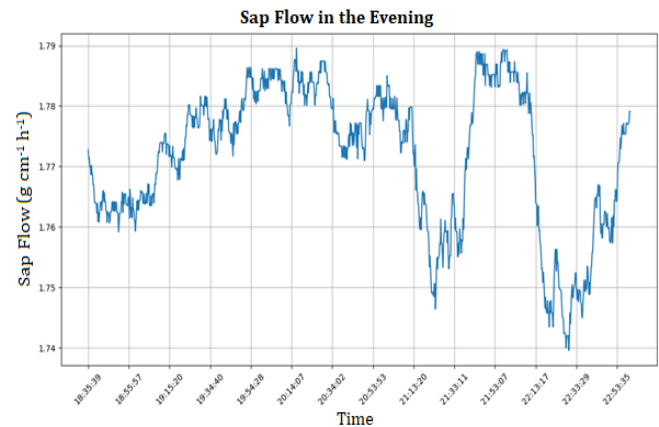

Figure 13. Measured Sap Flow in the Evening.

Figure 13 shows the measured sap flow between 18:00 and 23:00, and it presents some perturbations in its tendency, due, maybe, to some unseen issues in the installation of the temperature probes or the heater cartridge, but corroborating the behavior of the sap flow.

### 4. CONCLUSIONS

This project achieved its principal objective: Design a sap flow monitoring system with low-cost, easy-to-acquire, and cutting-edge technologies to offer an efficient and low-cost sap flow measurement system to make better and more efficient use of the water resources. The result of this research can be worthy for those who intend to develop applications aimed at agricultural development, specifically in the fruit trees area. The system can generate a database that allows the producers to make better decisions when planning the use of available irrigation water.

On the other side, we recognize the system is only a working prototype and can be improved in various aspects to enhance its performance, for instance; The need to run more tests for other types of trees, design a better power supply for longer operational periods, improve the handling and storage capacity of the database, and in general obtain a more robust measurement system.

### 5. REFERENCES

[1] Siddiqi, S. A., Al-Mulla, Y. A., McCann, I., AbuRumman, G., Belhaj, M., Zekri, S., ... & Rahman, S. (2021). *Smart monitoring, sap-flow, stem-psychrometer and soil-moisture measurements tools for precision irrigation and water saving of date palm.*

- [2] Ferreira, M. I., Silvestre, J., Conceição, N., & Malheiro, A. C. (2012). *Crop and stress coefficients in rainfed and deficit irrigation vineyards using sap flow techniques*. *Irrigation, Science*, 30, 433-447.
- [3] Davis, T. W., Kuo, C. M., Liang, X., & Yu, P. S. (2012). *Sap flow sensors: construction, quality control and comparison*. *Sensors*,12(1), 954-971.
- [4] Chartzoulakis, K., & Bertaki, M. (2015). Sustainable water management in agriculture under climate change. *Agriculture and Agricultural Science Procedia*, 4, 88-98.
- [5] Nadezhdina N (2018). *Revisiting the Heat Field Deformation (HFD) method for measuring sap flow*, iForest - Biogeosciences and Forestry, doi: 10.3832/ifer2381-011.
- [6] Nadezhdina N, Čermák J (1998) *The technique and instrumentation for estimation the sap flow rate in plants* (in Czech). Patent No.286438 (PV-1587-98). Bureau for Inventions and Discoveries, Prague.
- [7] Nadezhdina N, Čermák J, Nadezhdin V (1998) *Heat field deformation method for sap flow measurements*. In: Čermák J, Nadezhdina N (eds) *Measuring sap flow in intact plants*. Proceedings of 4th International Workshop, Židlochovice, Czech Republic, IUFRO Publ. Brno, Czech Republic: Mendel University, pp 72–92.
- [8] Ictinternational.kr, (2020).