

# Design and Performance Analysis of Several Antennas Using CST

Md. Mayn Uddin<sup>#1</sup>, Md. Uzzal Mia<sup>#2</sup>, Md. Kamruzzaman Sumon<sup>#3</sup>

<sup>1,2,3</sup>Department of Electrical and Electronic Engineering, Jatiya Kabi Kazi Nazrul Islam University, Trishal, Mymensingh-2224, Bangladesh

\*\*\*

**Abstract:** The demand for smaller, lighter, and higher-performance antennas in communication systems has increased. Microstrip antennas are one of the most common antenna types that can suit these requirements. They have numerous advantages, including small size, ease of fabrication, and low cost. In addition to these benefits, they have drawbacks, such as limited bandwidth. The performance parameters of antennas, such as directivity, voltage standing wave ratio, S-parameter, gain, and directivity, have been calculated and compared. The copper-coated substrate material is FR-4 lossy with a dielectric constant of 4.4 and a thickness of 1.5 mm, and the design frequency is 2.4 and 8-12GHz. The feeding mechanism utilized is a 50-ohm microstrip feed line. This paper compares five types of antennas: rectangular microstrip patch antenna, circular patch antenna, dipole antenna, array antenna, and double T shape microstrip patch antenna. We aim to achieve higher gain and efficiency while minimizing the size and cost. Therefore, we are carefully choosing to construct an antenna with a specific frequency and wavelength to meet the required gain and efficiency. The antenna has three slots, one on the ground plane and two on the patch. CST Microwave studio tools replicate the desired patch antenna design. We have used CST microwave tools software to implement this proposed model and achieve good results. Our utmost effort has been made to achieve optimum accuracy.

**Keywords** - Antennas, Gain, Directivity, S-parameter, Polar Plot, VSWR.

## 1. INTRODUCTION

Today's digital communication systems require compare, compatible, and affordable antennas. An antenna is an electrical inducer, that converts electromagnetic waves into electrical signals. An antenna produces radiation. When the current inside the conductor is altered, radiations occur by directly increasing or reducing the current wire. This results in a discontinuity within the conductor causing the antenna emitting [1]. Microstrip patch antennas have several advantages over traditional antennas, including reduced weight, volume, and cost, a lower profile, smaller dimensions, easy manufacture, and

conformance [2]. Microstrips are used in a variety of applications such as radars, telemetry, aircraft, navigation, radio frequency identification (RFID), biomedical systems, the medical industry, mobile and satellite communications, missile systems, a global positioning system (GPS) for remote sensing, and so on, due to their compact size and planar structure [3]. The patch, substrate, and ground plane are the three essential components of the MPA design. The copper-based component known as the radiating patch is connected to the top layer of the substrate, while the ground plane is connected to the bottom layer, as depicted in Figure 1 [4]. Due to its characteristics and ability to adopt any geometrical shape, MPAs have been one of the best candidates for wireless applications. MPAs are divided into four categories [5]. These antennas can be designed and shaped based on the parameters. Patch antennas are available in several shapes, including rectangles, squares, triangles, and circles. A comparison of various patch antenna shapes is included [6]. Circular and rectangular MPAs are popular due to their construction and wide range of applications, providing feedline flexibility, a wide frequency range, and increased bandwidth. Each change in the patch's design can result in a new application. This study introduces a new circular antenna approach that uses aperture-coupled line feeding as described in the reference [7].

Based on performance, a circular and rectangular antenna operating in the X band at a resonant frequency of 10 GHz are compared [8], with the rectangular patch antenna outperforming the circular. For a variety of uses, microstrip antennas can also be constructed in the forms of E, Z, T, S, H, and F [9], which describes four different shaped antennas and their outcomes. The examination of changes in antenna properties due to form change is presented. A T-shaped device that can switch its polarization in both directions i.e. left and right circular polarization [10]. For wireless communication systems, the designed antenna primarily targets the IEEE 802.11b/g frequency spectrum (2.4-2.5GHz). With symmetry on two polarization modes, 8.7 dB maximum gain and 7.1% bandwidth effectiveness are achieved. It behaves as an internal antenna. Its principal application is with microwave frequencies. A patch antenna is similar to a

patch of different-shaped metal foil on a printed circuit board (PCB), with a metal foil ground plane on the other side.

It is created of two metallic plates layered on ascend of one another and mounted on a small, rectangular, flat surface. Compared to conventional antennas, microstrip patch antennas provide additional benefits and prospects.

- Less expensive
- Lighter in weight
- Lower volume
- Lower profile
- Smaller in size
- Easier to fabricate and conform.

A Microstrip Antenna's most basic configuration consists of a ground plane and a radiating patch on opposite sides of a dielectric substrate. When current from a feed line touches the strip of a microstrip or patch antenna, electromagnetic waves are formed. The patch's waves begin to spread out from the width side. We designed and built a microstrip patch antenna. The patch antenna efficiency at 2.4 GHz is roughly 80%, according to the measurements. There are several techniques to increase antenna bandwidth, such as utilizing different antenna shapes, cutting slots, probe feeding, and thickening a substrate with a low dielectric constant.

Microstrip antennas have the following advantages:

- Conformal structures are conceivable (curves are simple to build as long as they are just in one direction).
- Low fabrication costs
- Forming a big array with half-wavelength or less spacing is simple.
- Compact size

Disadvantages include:

- Limited bandwidth
- Increased complexity
- Low power handling.

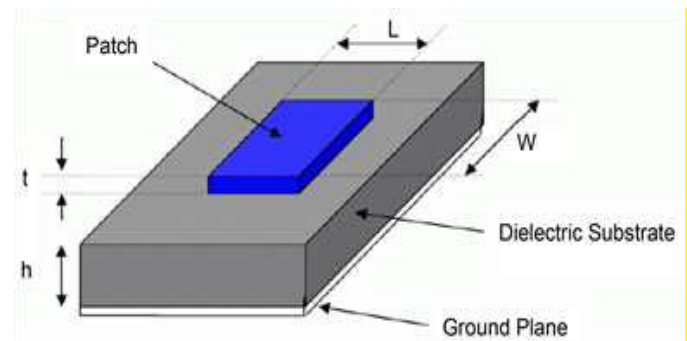
## 2. OBJECTIVES

We want to compare the gain efficiency, directivity, S-parameter, and polar plot for rectangular, circular, dipole, array microstrip patch antenna, and double T-shape patch antennas in the 8-12 GHz frequency range and identify the ideal operating frequency for these antennas. We aim to achieve increased gain and efficiency while minimizing size and reducing cost. As a result, we must construct an antenna with a specified frequency and wavelength to achieve the needed gain and efficiency while also meeting the requirements of minimal size and low cost. Evaluating

and comparing the performance of different frequencies is critical. The antenna is being developed with the CST microwave studio tool.

## 3. METHODOLOGY

In our methodology, we explain our process for collecting data. For example, we detail how we run experimental tests on samples, and use current data to develop new studies. Our methodology section includes a full description of our activities and procedures. Initially, we learned about the antenna that we aim to create. We learn how to use CST Microwave Studio tools for antenna design. Following that, we will design and simulate the antennas, and then present the antenna output for all of them. Finally, we compare different antennas.



**Figure 1: Structure of a Microstrip Patch Antenna**

Figure 1 shows the layout of a simple Microstrip Patch Antenna (MPA), The MPA is built using microstrip line feeding technology, which results in a smooth antenna surface design. Different designs are created for the different frequencies like the 2.4 GHz frequency, which is widely used in Applications in science, industry, and medicine because it is an unlicensed frequency [11]. All of these proposed antenna design is simulated using CST microwave studio tools. Below, you can find our work plan and a suitable flowchart.

#### 4. PROPOSED MODEL

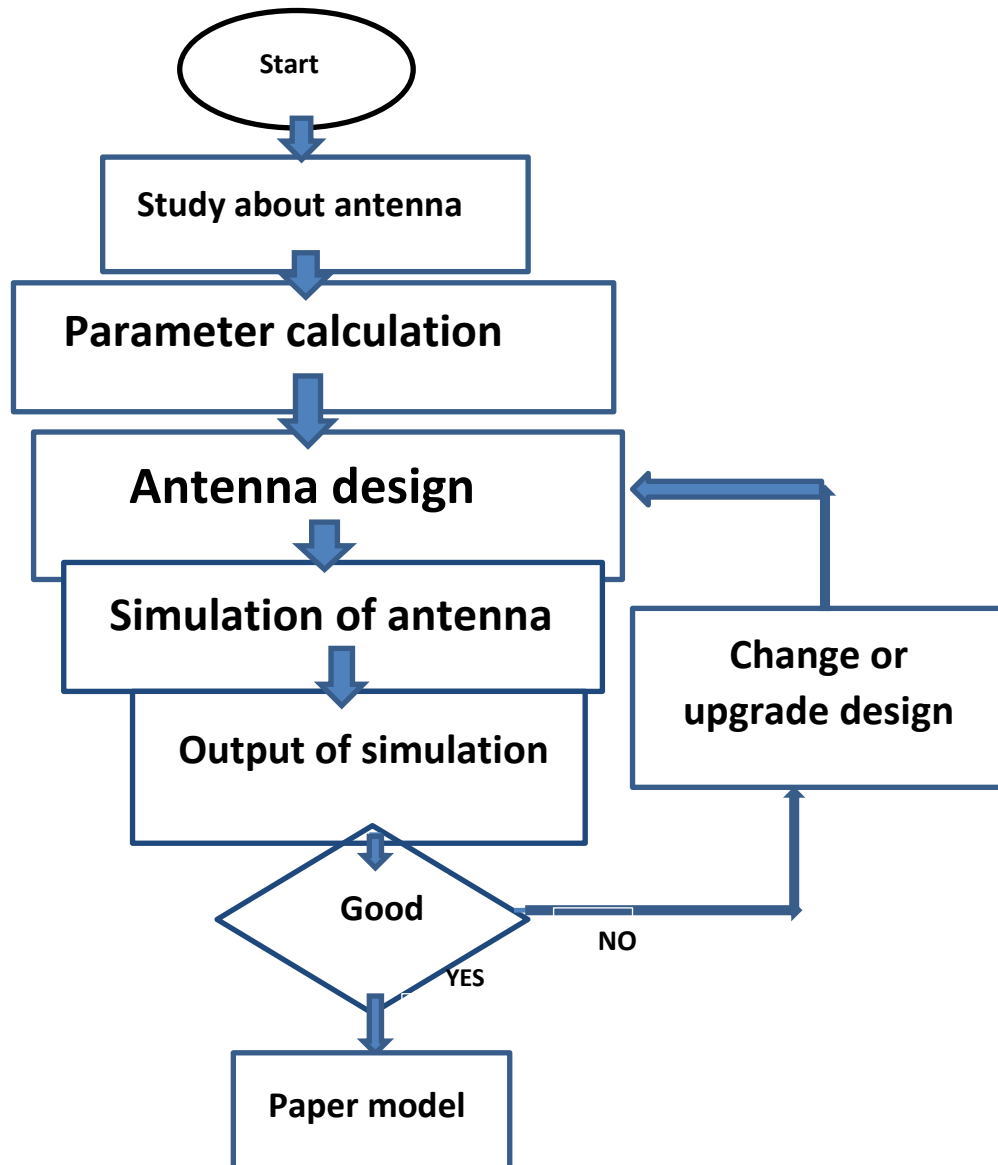


Figure 2: Flowchart

## 5. Literature Review and Theoretical Framework:

### Rectangular Microstrip Patch Antenna

Antennas are important components in signal transmission and reception. Microstrip patch antennas are widely used in wireless communication systems because of their advantageous characteristics, which include compatibility, low cost, small weight, and ease of fabrication. [12].

Industrial, Scientific, and Medical band with 2400-2490 MHz is the most popular band type utilized for microstrip patch antennas in residential, office, and industrial applications. WLAN is an IEEE (Institute of Electrical and Electronics Engineers) wireless network (Wireless Local Area Network) IEEE 802.11 is the overall name for the standard, and IEEE 802.11b and IEEE 802.11g are the ISM wireless LAN standards that operate in the 2.4 GHz range. Many studies have been carried out to increase the bandwidth and gain of antennas [13][14][15]. Owing to its low cost and ease of production, the Microstrip Patch Antenna finds extensive application in wireless communication. Its direct printing on PCB makes it very convenient. In this research, the substrate used is a lossy FR-4 material. Mounting a metal patch over a wider ground plane is necessary for the microstrip antenna element. A microwave substrate having a relative permittivity of two to ten is usually used to print the patch. Depending on the application, however, A variety of materials may be used. The lowest loss and highest radiation productivity are typically seen in air or low-thickness froths. [16][17]. A crucial part of the microstrip antenna is the following patch, which has an impact on the radiation pattern, impedance matching, bandwidth, return loss, interface current dispersion, and harmonic suppression. [18][19]. A metallic radiating surface on top of a connected dielectric foundation with a predetermined thickness forms the basis of an MSA's usual construction. [20].

Nowadays, the surface patch antenna is widely utilized due to its multiple benefits. However, it has some disadvantages, but they are very little to its numerous advantages. MSA offers the following advantages: -

- a) Lightweight;
- b) Low-profile;
- c) Dual and triple frequency capability

The disadvantages of antennas are:

- Low gain
- Low bandwidth.

To address this issue, the designer designed a variety of microstrip antennas for their test. They first created an MSA with a single substrate layer and then calculated factors such as gain, visibility, return loss, plus voltage standing waves ratio. After that, they produced a second MSA with two underlying layers, stacking the second layer on top of the first using the same material. Finally, they cut diagonal slots into the MSA, and in the final effort, slots were cut in all four corners of the MSA, For a comparison of the antennas' performance metrics. This initiative intends to fulfill the expanding need for wireless connectivity in a range of contexts. The primary focus of this research is to: -

#### A. Boost the bandwidth of an antenna.

The antenna's range can be enhanced by increasing the antenna's height and lowering the dielectric constant.

#### B. Boost an antenna's gain.

A patch's form can be changed to increase a gain; in this paper, a rectangular patch is employed since it reduces patch area by 65-70 percent while simultaneously improving gain.

**Antenna Design and its Dimensions:** Fig. 3 shows the suggested antenna mathematical terms, which consists of a stripes input line, patch, and insulating substrate. With FR-4 lossy, the rectangular patch is segregated from the underlying plane. A dielectric substrate that has the following measurements [21].

**Table 1.** Proposed Antenna Dimensions [20]

Parameters	Values
Length of Substrate	65
Width of Substrate	65
Height of Substrate	1.6
Length of Patch	28.68
Width of Patch	36
Length of feedline g	0.035
Width of feedline	1.44

The table above displays all of the MSA's planned parameter dimensions. The construction of a rectangular microstrip patch antenna is seen in the image. It is composed of a base plane, a patch, and a substrate of dielectric (FR-4). [14]. The antenna's resonance frequency ("fo"), substrate thickness ("h"), and substrate material's dielectric constant ("εr") are important factors to consider. In this investigation, appropriate substrate materials

include FR-4 with relative dielectric constant  $\epsilon_r=4.4$ , height  $h=1.6$  mm, and ground thickness of  $t=35$   $\mu\text{m}$ . This study seeks to reduce return loss by maintaining  $h$ ,  $\epsilon_r$ , and  $f_0$  constant while optimizing other parameters. Using the supplied values, the patch width ( $W_p$ ) is computed using equation (1) as follows:  $W_p$

$$W_p = \frac{c}{2f_0} \sqrt{\frac{2}{\epsilon_r + 1}} \dots\dots\dots(1)$$

Where:

$c$  = free-space light velocity.

$f_0$  = resonance frequency.

$\epsilon_r$  = dielectric constant.

Since microstrip antennas do not have a homogeneous structure, it causes a change in the electrical transmittance value.

$\epsilon_{\text{reff}}$  is calculated by equations 2 and 3.

$$\frac{w_p}{h} > 1 \dots\dots\dots 2$$

$$\epsilon_{\text{reff}} = \frac{\epsilon_r + 1}{2} + \frac{\epsilon_r - 1}{2} \left[ 1 + 12 \frac{h}{w_p} \right]^{-0.5} \dots\dots\dots 3$$

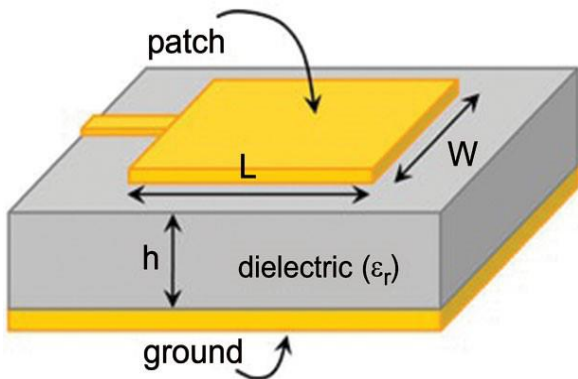


Figure 3: Microstrip Patch Antenna.

$L_{\text{eff}}$  is the effective length of the patch and  $\Delta L$  represents the length augmentation calculated by equations 4 and 5.

$$L_{\text{eff}} = \frac{1}{2fr\sqrt{\epsilon_{\text{reff}}}} * \frac{1}{\sqrt{\mu_0\epsilon_0}} \dots\dots\dots(4)$$

$$\Delta L = \frac{0.412h(\epsilon_{\text{reff}}+0.3)\left(\frac{h}{w_p}+0.264\right)}{(\epsilon_{\text{reff}}-0.258)\left(\frac{h}{w_p}+0.8\right)} \dots\dots\dots(5)$$

$$L_p = L_{\text{eff}} - 2\Delta L = \frac{1}{2fr\sqrt{\epsilon_{\text{reff}}}} * \frac{1}{\sqrt{\mu_0\epsilon_0}} - 2\Delta L \dots\dots\dots(6)$$

As a result,  $W_p=36$  mm,  $L_p=28.68$  mm are found. The width of the ground plane is determined as  $W_g=65$  mm and the length as  $L_g=65$  mm. The Microstrip feeding method is used as the feeding method and the length of the transmission line is optimized as 14.75 mm and the thickness as 1.6 mm. The width of the transmission line is determined by changing it according to the impedance match. Two symmetrical slots are made on the patch surface of the antenna. Another slot was opened on the ground plane. The simulations of the designed antenna are carried out on the CST Studio Suite.

**Design:** How to design the rectangular patch antenna is given below.

Step 1: Open CST microwave studio.

Step 2: Select a new project then mw/RF and Optical then select antennas then select planar (patch, slot) then select time domain.

Step 3: Select minimum and maximum frequency range and give a working frequency list then select all monitors like E-field, H-field, far-field, etc.

Step 4: Select modeling then select brick then press ESC and give the value as given below.

Ground: Xaxis  $-w/2$  to  $w/2$ , Yaxis  $-l/2$  to  $l/2$ , Zaxis 0 to  $-g$ .

Substrate: Xaxis  $-w/2$  to  $w/2$ , Yaxis  $-l/2$  to  $l/2$ , Zaxis 0 to  $-g$   
 feedline: Xaxis  $-wf/2$  to  $wf/2$ , Yaxis 0 to 18.16, Zaxis 0 to  $g$   
 patch: Xaxis  $-wp/2$  to  $wp/2$ , Yaxis  $-lp/2$  to  $lp/2$ , Zaxis  $h$  to  $h+g$ .

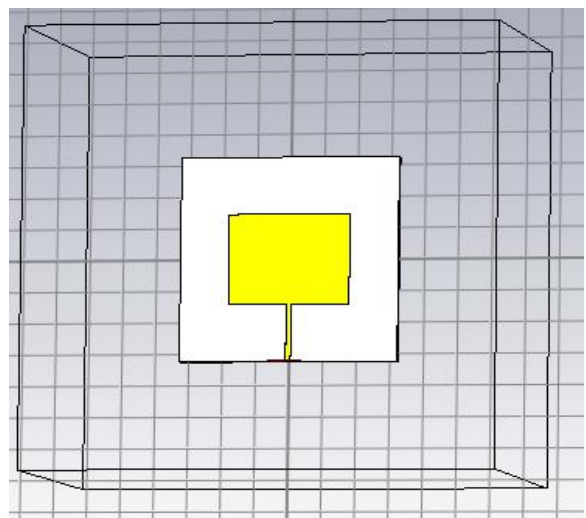


Figure 4: Rectangular Patch Antenna.

**Simulation Output:**

Antenna simulation steps are given below.

Step 1: Calculate waveguide ports by macros function.

Step 2: Select simulation then select pick face of feed line then select waveguide port option and give the value from the calculation.

Step 3: Select simulation then select setup solver and set accuracy -40db, normalized to fixed Impedance 50ohm then press start.

Step 4: After completing the simulation double-click far-fields and select the frequency which the far-field wants to show.

Step 5: Make a performance table at different frequencies which includes operating frequency, total efficiency, radiation efficiency, gain, and directivity.

Step 6: To show S-parameter double click 1-D results then select S-parameter and to show bandwidth add curve marker at -10db points.

Step 7: To show VSWR double-click 1-D results and Select the VSWR option.

Step 8: To show the polar plot double click far-fields and select polar form.

Step 9: To show a 2-D plot double click Far-fields and select 2D.

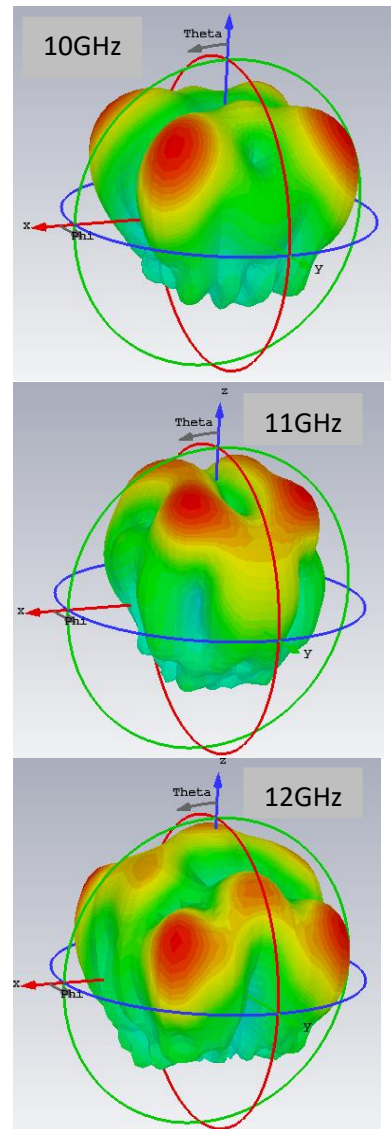
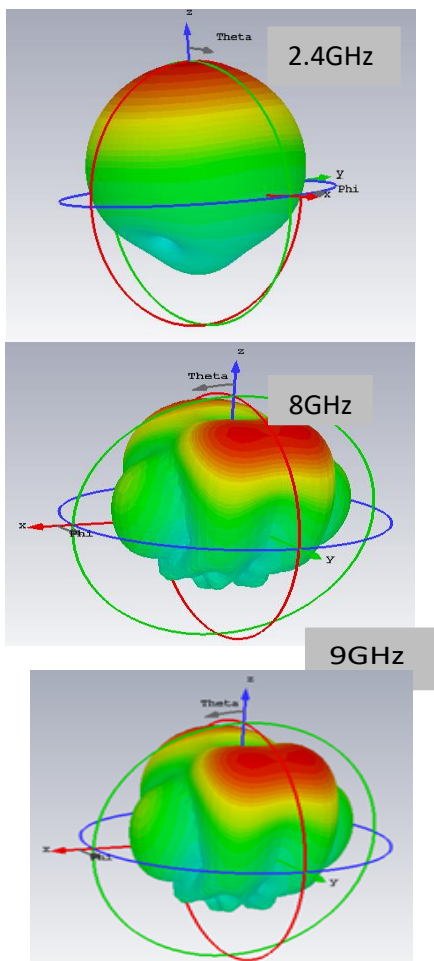


Figure 5: Rectangular Patch Antenna Far-fields at Different Frequencies.

Table 2: Performance Analysis of Rectangular Patch Antenna at Different Frequencies

Frequency	Total efficiency	Radiation efficiency	Gain	Directivity
2.4GHz	-3.90dB	-3.33dB	4.37dB	7.71dBi
8GHz	-10.30dB	7.30dB	0.50dB	7.80dBi
9GHz	-6.40dB	-4.89dB	4.28dB	9.17dBi
10GHz	-5.08dB	-4.81dB	4.24dB	9.06dBi
11GHz	-8.70dB	-6.94dB	2.57dB	9.51dBi
12GHz	-4.80dB	-4.72dB	2.63dB	7.35dBi

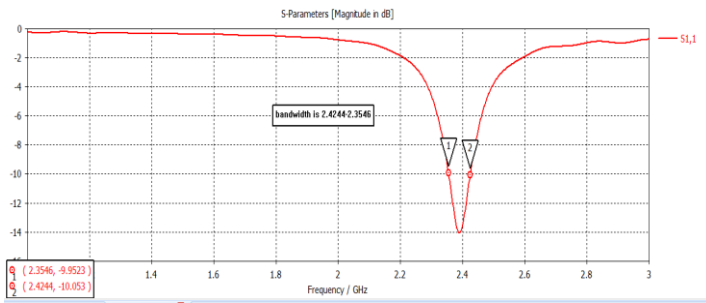


Figure 6: S-parameter of Rectangular Patch Antenna.

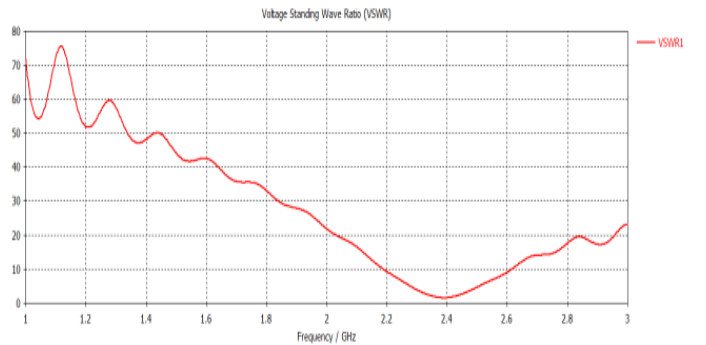


Figure 7: VSWR of Rectangular Patch Antenna.

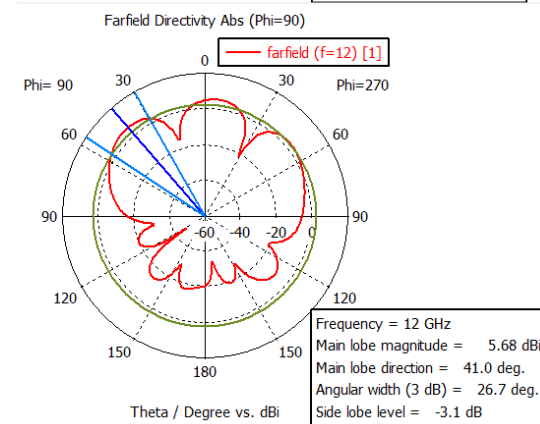
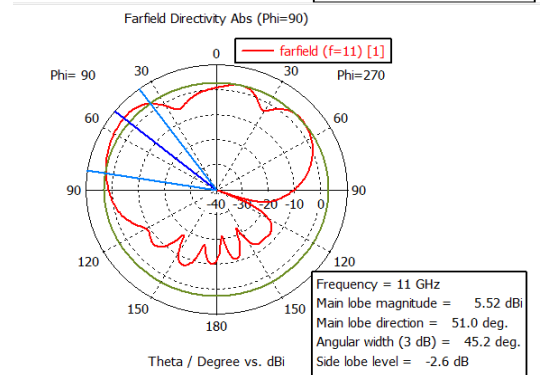
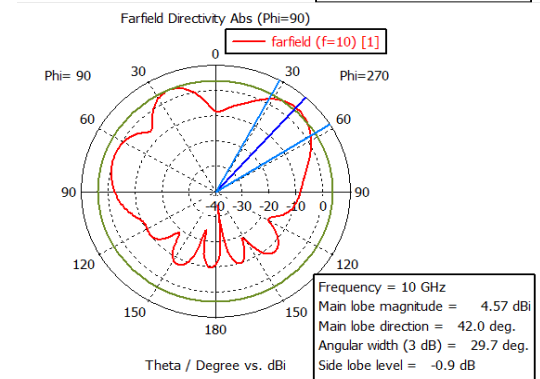
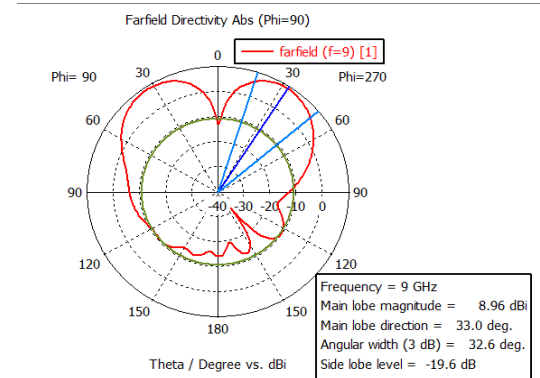
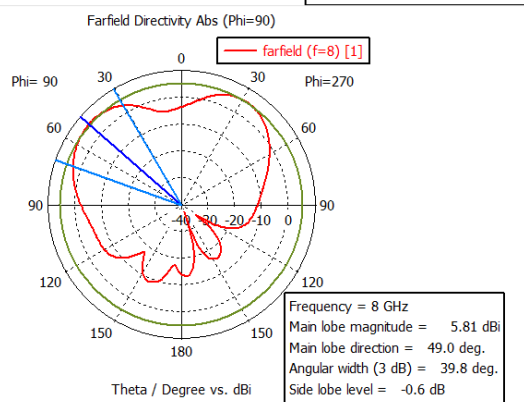
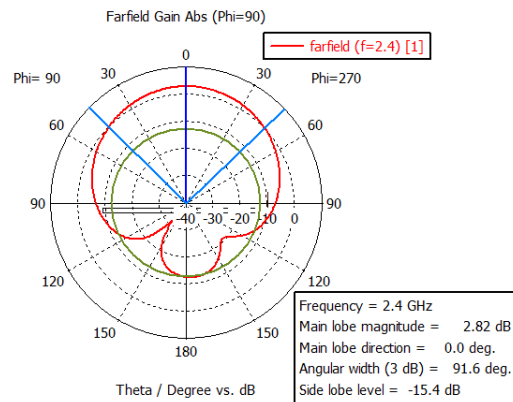


Figure 8: Polar Plot at Different frequencies of Rectangular Patch Antenna.



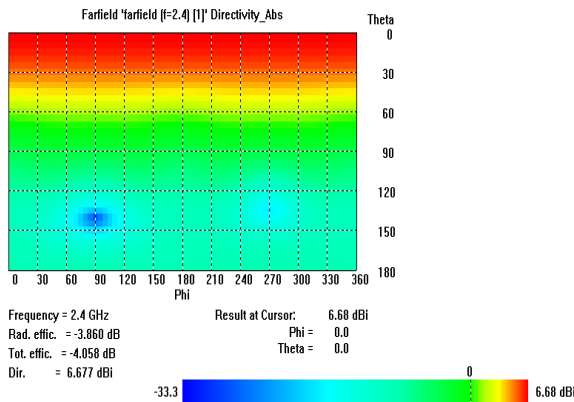


Figure 9: 2-D Plot of Rectangular Patch Antenna.

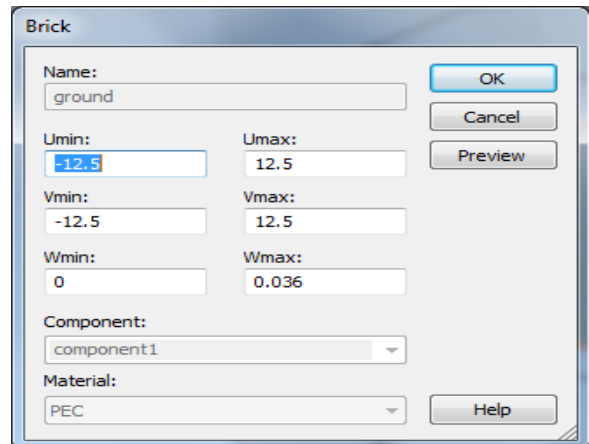


Figure 10: Ground Specifications.

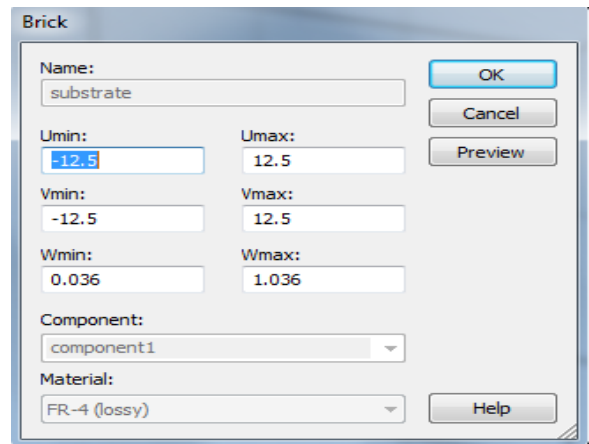


Figure 11: Substrate Specifications.

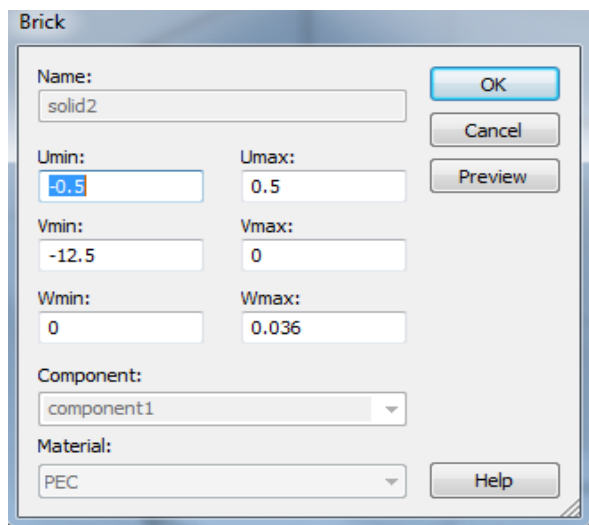


Figure 12: Feed-line Specifications

### Circular Patch Antenna

The circular patch antenna is made of FR4-lossy, which has a gain of 3 dB and is 4.4 KE, 1.6 mm high. It measures return loss, bandwidth, directivity, antenna gain, and productivity, among other antenna characteristics. Microstrip antenna with a circular patch can be used for WLAN (wireless local area network) applications, Bluetooth, and Internet of Things (IoT) connections. The

$$\text{radius of the circular antenna is } = \sqrt{\frac{(W+Dh) \times (H+Dh)}{2}}$$

Where h is Height

W is Width

D is Dielectric height.

The advantage of circularly polarized antennas is that they do not require specific antenna orientation or signal immunity in the case of multipath propagation. Microstrip antennas with circular polarization are used in worldwide positioning satellite (GPS) systems. They are quite expensive due to their location and limited size. The strips are used in mobile communication, RFID (radio frequency identification), and healthcare.

#### Design:

How to design the rectangular patch antenna is given below step by step.

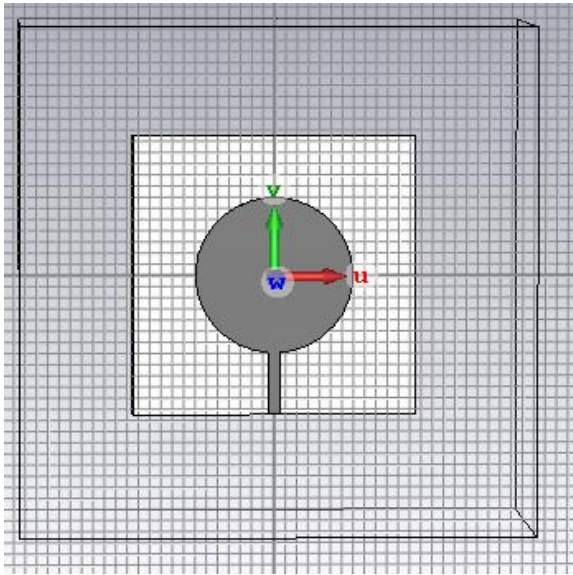
Step 1: Open CST microwave studio.

Step 2: Select a new project then mw/RF and Optical then select antennas then select planar (patch, slot) then select time domain.

Step 3: Select minimum and maximum frequency ranges and give a working frequency list then select all monitors like E-field, H-field, far-field, etc.

Step 4: Select modeling then select brick then press ESC and give the value as given below.





**Figure 13: Circular Antenna**

**Simulation Output:**

Antenna simulation steps are given below.

Step 1: Calculate waveguide ports by macros function.

Step 2: Select simulation then select pick face of feed line then select waveguide port option and give the value from the calculation.

Step 3: Select simulation then select setup solver and set accuracy -40db, normalized to fixed Impedance 50ohm then press start.

Step 4: After completing the simulation double click far-fields and select frequencies which far-fields want to show.

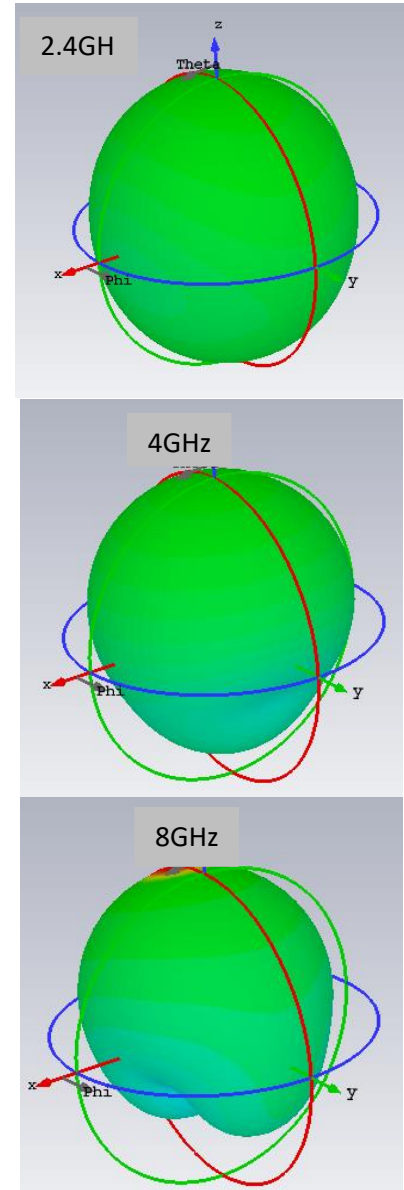
Step 5: Make a performance table at different frequencies which includes operating frequency, total efficiency, radiation efficiency, gain, and directivity.

Step 6: To show the S-Parameter double click 1-D results then select S-parameter and to show bandwidth add a curve marker at -10dB points.

Step 7: To show the VSWR double-click 1-D results and select the VSWR option.

Step 8: To show the polar plot double click far-fields and select polar form.

Step 9: To show a 2-D plot double click Far-fields and select 2-D.



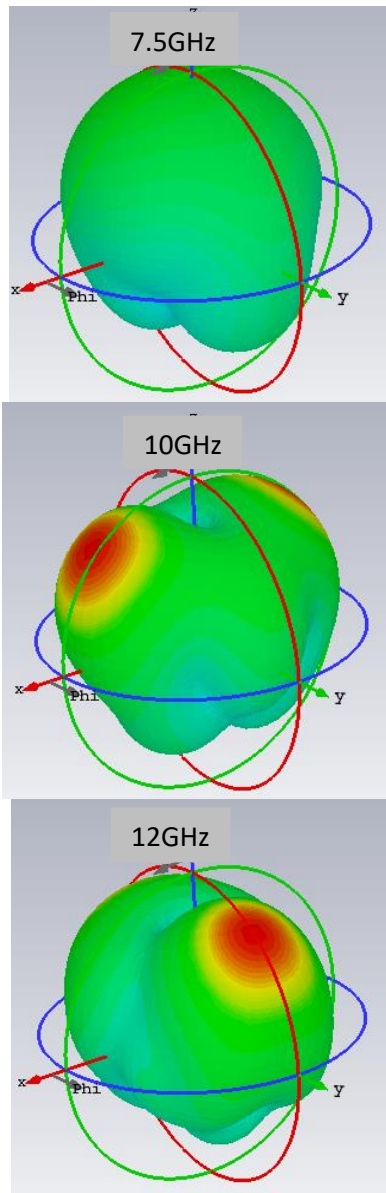


Figure 14: Circular Antenna Far-fields at Different Frequencies.

Table 3: Performance at Different Frequencies of Circular Antenna.

Frequency	Total efficiency	Radiation efficiency	Gain	Directivity
2.4 Ghz	-30.59db	-15.93db	-13.26db	2.673dbi
4 GHz	-17.19dB	-6.836dB	-1.472dB	5.364dBi
7.5 GHz	-13.12dB	-6.397 dB	-0.33 dB	6.73 dBi
8 GHz	-13.75 dB	-7.28 dB	-0.67 dB	6.60 dBi
10 GHz	-4.27 dB	-3.72 dB	2.69 dB	6.41 dBi
12 GHz	-6.02 dB	-4.05 dB	2.291dB	6.35dBi

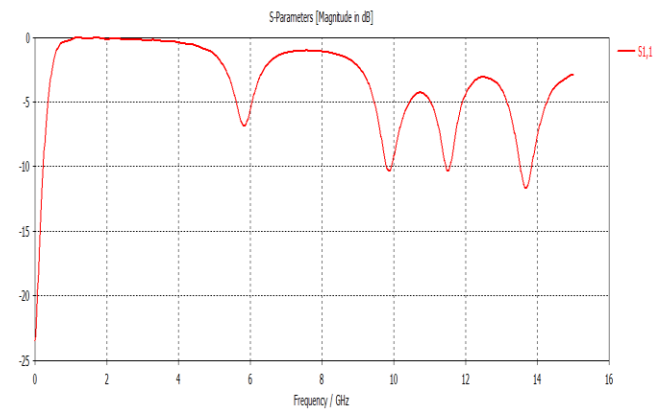


Figure 15: S-parameter of Circular Antenna.

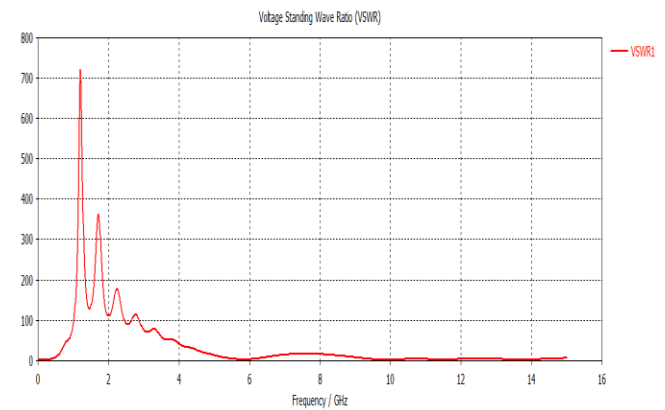


Figure 16: VSWR of Circular Antenna.

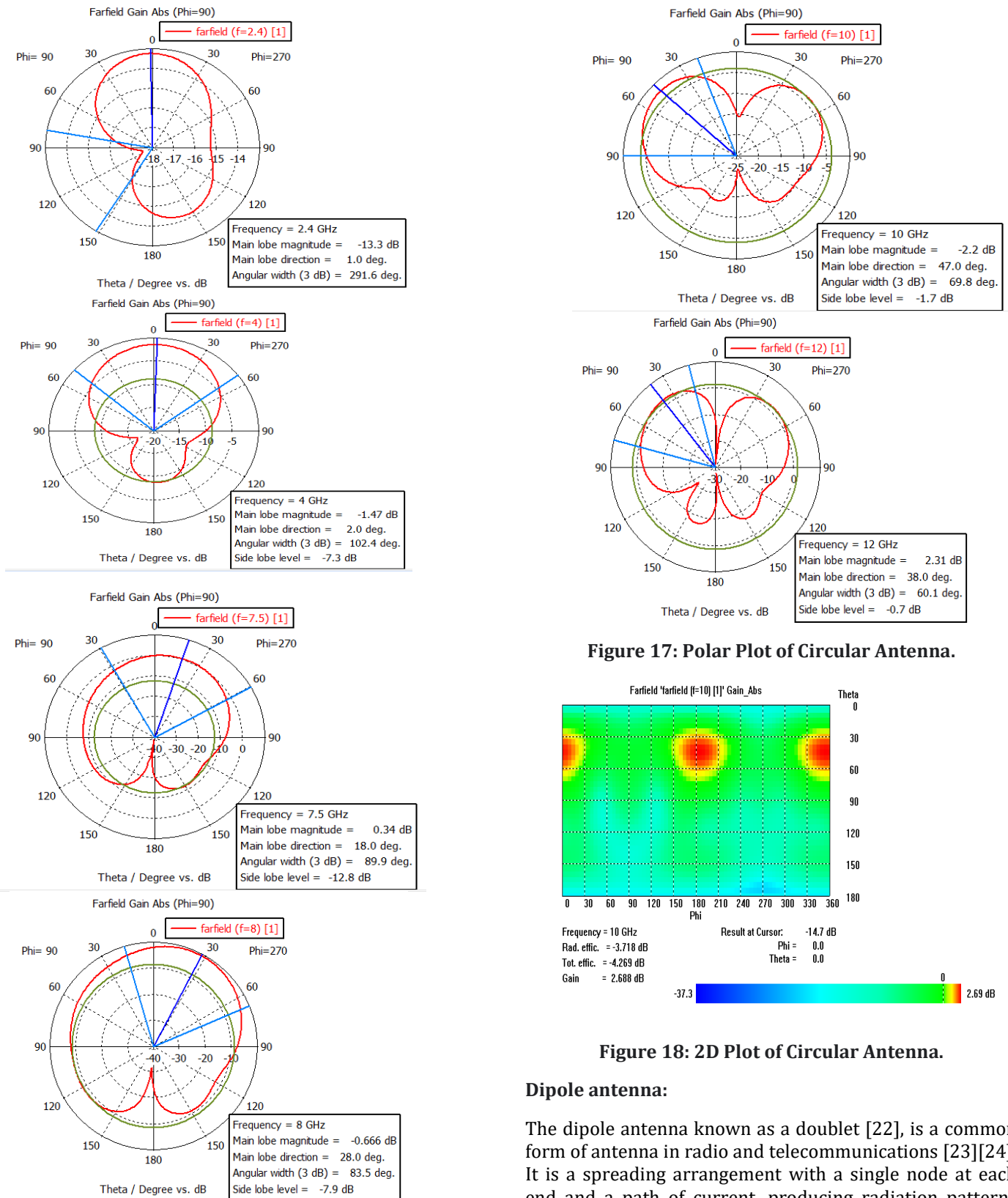


Figure 17: Polar Plot of Circular Antenna.

Figure 18: 2D Plot of Circular Antenna.

**Dipole antenna:**

The dipole antenna known as a doublet [22], is a common form of antenna in radio and telecommunications [23][24]. It is a spreading arrangement with a single node at each end and a path of current, producing radiation patterns

like those of a basic electric dipole [25].The transmitter sends current to the antenna, which is made up of two similar conducting metals [26], like as power cables or metal poles, and the antenna picks it up. An output signal is produced by the antenna's receiver between its parts. Each wire is linked to every side of the feed line leading to the transmitter or receiver. A monopole antenna is made out of a single rod or conductor with one end linked to the feed line [27][28]. The most frequent kind is the center-fed half-wave dipole, which is a little less than half a wavelength. When a half-wave polarity is positioned vertically, it produces an omnidirectional antenna; when it is positioned horizontally, it produces a weakly directional antenna. The radiation distribution of a half-wave dipole is highest perpendicular to the conductor and zero in the axial direction. [29][30].

**Application:**

Dipole antennas are used in many applications, both as antennas and as components of larger complex antennas where they may act as the dominant radiating element. They are employed in several radio systems, such as those for transmission acceptance, common radio reception, and two-way radio communication, along and numerous other uses.

**Antenna advantage:**

They're both inexpensive and profitable. The benefit of using dipole antennas is that they can receive balanced transmissions. The device's two-pole configuration allows it to receive signals over a wide frequency range. It also aids the device in resolving signal conflicts while maintaining optimal reception quality.

**Antenna Design:**

A parameter list is given below.

Name	Expression	value	description
R	2.5	2.5	Radius of wire
gap	20	20	The gap between two wire
Zo	50	50	Impedance
L	111.75	111.75	Length

**Figure 19: Parameter list of dipole antenna.**

How to design the Dipole antenna is given below step by step.

Step1: Open CST microwave studio.

Step 2: Select new project then mw/RF and Optical then select antennas then select wire antenna then select time domain.

Step 3: Select minimum and maximum frequency ranges and give a working frequency list then select all monitors like E-field, H-field, far-field, etc.

Step 4: Select modeling then select bond wire then press ESC and give the value as given up.

Outer radius: R inner radius: 0

X-center: 0 Y-center: 0.

Z-min: -L/2 Z-max: L/2.

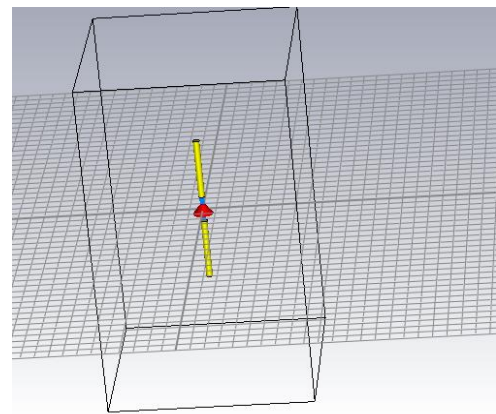
Material: Annulled copper.

For substrate:

Outer radius: R Inner radius: 0.

Z-min: -gap/2 Z-max: gap/2.

Material: copper annealed.



**Figure 20: Dipole Antenna.**

**Simulation output:** Antenna simulation steps are given below.

Step 1: Calculate waveguide ports by macros function.

Step 2: Select simulation then select pick face of feed line then select waveguide port option and give the value from the calculation.

Step 3: Select simulation then select setup solver and set accuracy -40dB, normalized to fixed Impedance 50ohm then press start.

Step 4: After completing the simulation double click far-fields and select the frequency which far-field want to show.

Step 5: Make a performance table at different frequencies which includes operating frequency, total efficiency, radiation efficiency, gain, and directivity.

Step 6: To show S-parameter double click 1-D results then select S-parameter and to show bandwidth add curve marker at -10db points.

Step 7: To show VSWR double-click 1-D results and select VSWR option.

Step 8: To show the polar plot double click far-fields and select polar form.

Step 9: To show a 2-D plot double click Far-fields and select 2D.

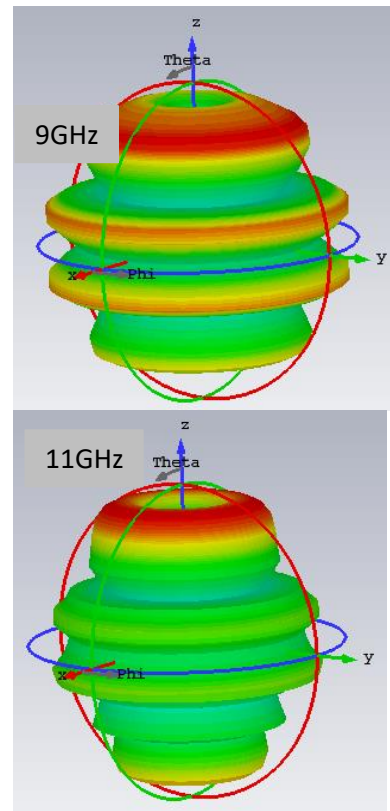
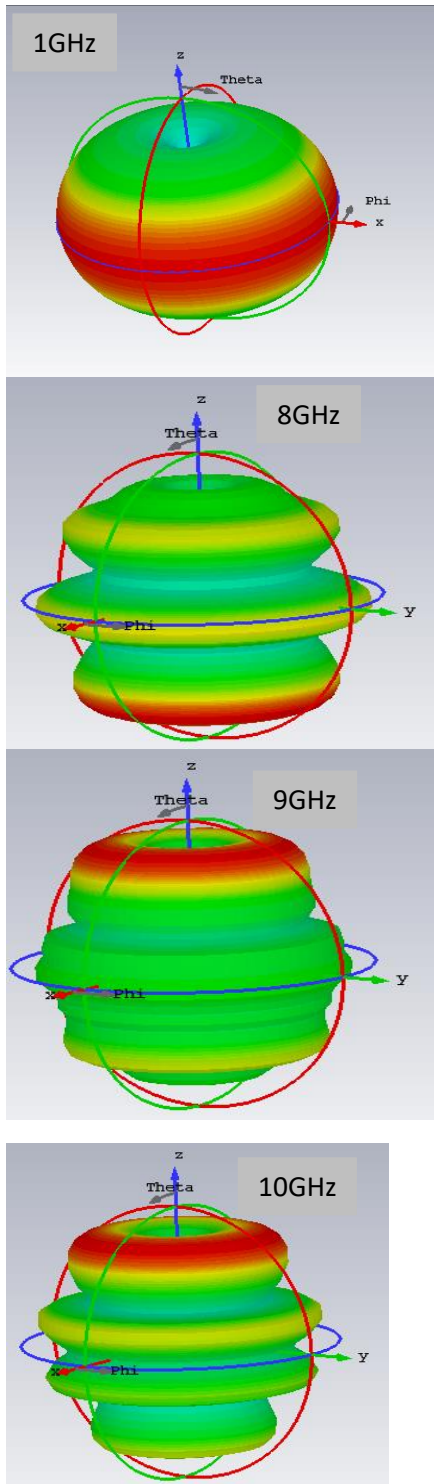
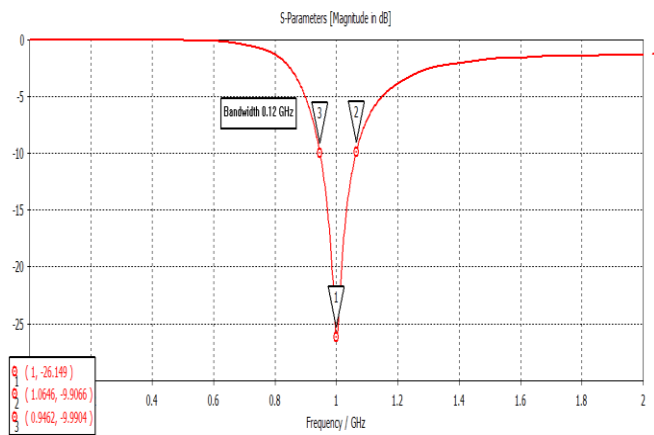


Figure 21: Far-fields at Different Frequencies of Dipole Antenna.

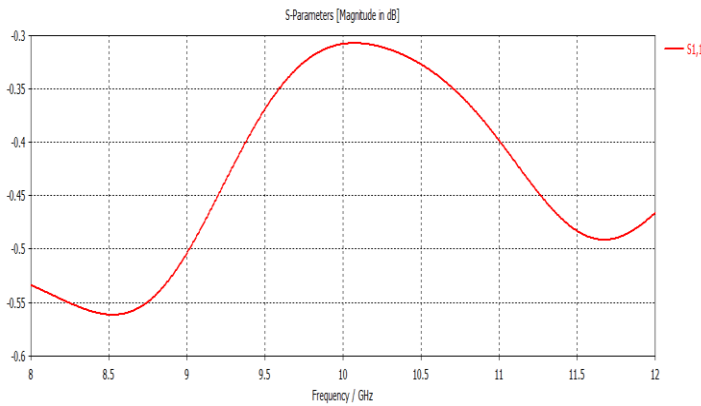
Frequency	Total efficiency	Radiation efficiency	Gain	Directivity
1 GHz	-0.041dB	-0.031dB	2.08dB	2.11dBi
8 GHz	-9.36dB	-0.0034dB	4.80dB	4.80dBi
9 GHz	-9.61dB	0.0046dB	5.29dB	5.30dBi
10 GHz	-11.64dB	-0.00098dB	5.53dB	5.53dBi
11 GHz	-10.58dB	-0.0043dB	3.74dB	3.75dBi
12 GHz	-9.94dB	-0.0129dB	6.39dB	6.40dBi

Table 4: Performance Analysis at Different Frequencies of Dipole Antenna.

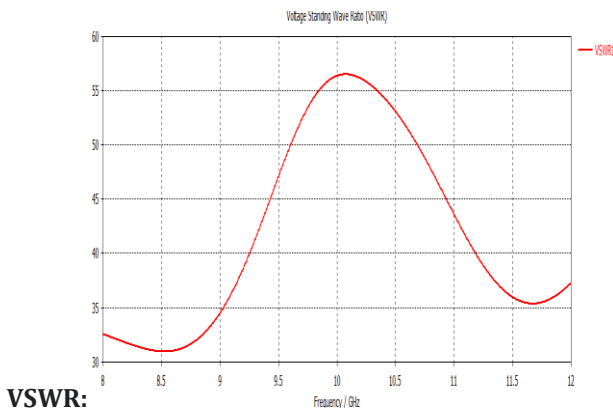
**S-parameter:**



**Figure 22: S-parameter of Dipole Antenna.**

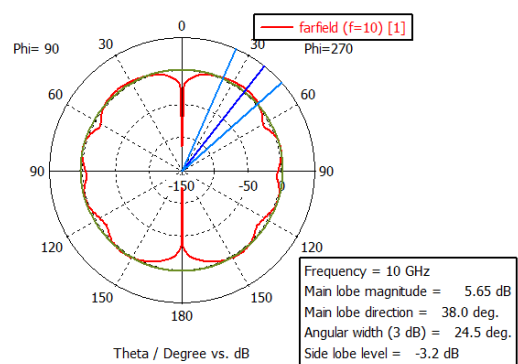
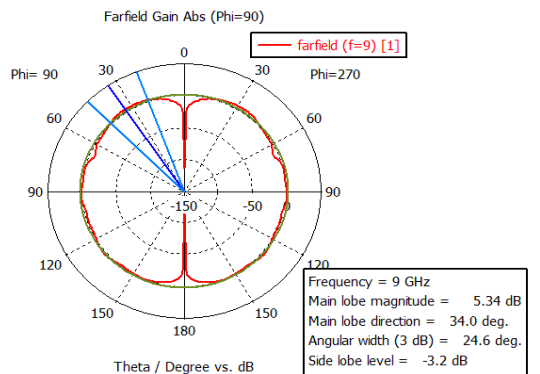
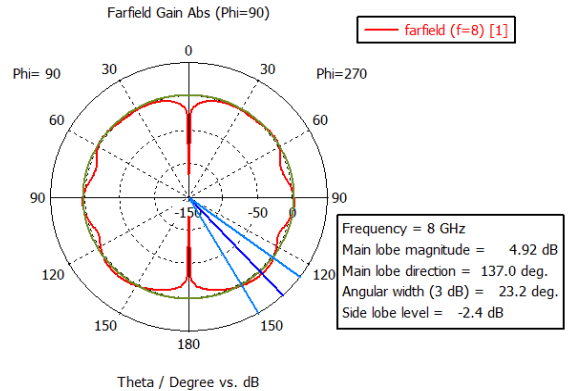
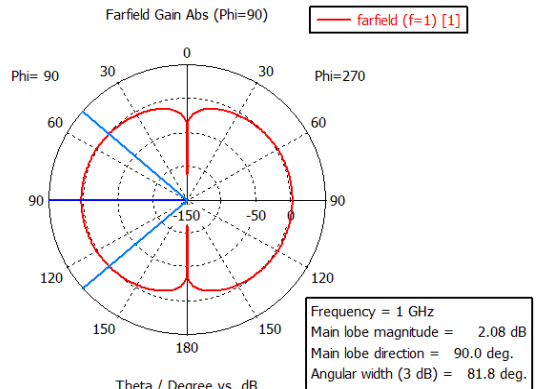


**Figure 23: S-parameter at 8-12 GHz.**



**VSWR:**

**Figure 24: VSWR Graph of Dipole Antenna.**



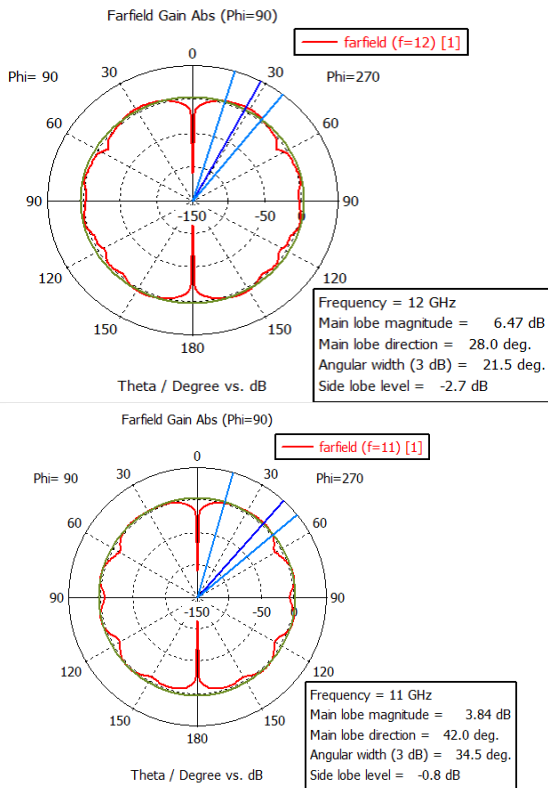


Figure 25: Polar Plot at Different Frequencies of Dipole Antenna.

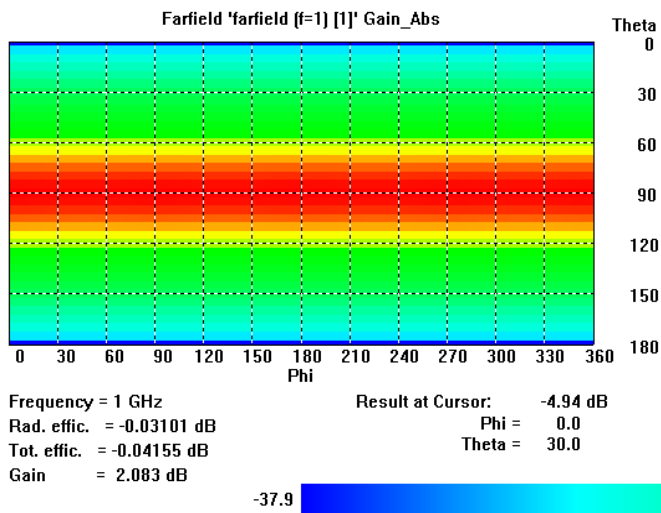


Figure 26: 2-D Plot of Dipole Antenna.

**Array Antenna**

An antenna array is a collection of linked antennas that functions as a single antenna for both radio wave transmission and reception. Typically, feed lines are used

to link separate antennas to a single transmitter or receiver. Each antenna emits radio waves that combine and superpose to increase the intensity of the radiation in targeted directions while blocking out the radiation in other regions. When the receiver is utilized for receiving, the distinct radio frequency currents from each of the various antennas combine in the right phase relationship to amplify signals from desired directions while attenuating signals from undesirable ones. Compared to a single element, a multi-element antenna array can provide a less wide beam of electromagnetic radiation, better gain, or both. Generally speaking, the narrower the beam and the higher the gain, the more separate antenna components that are employed. There are some antenna arrays made up of thousands of separate antennas. Among the many functions of arrays are gain enhancement, route diversity (MIMO) [31], enhanced communication dependability, direction determination, electronic steering of the radio beam in various directions, and cancellation of interference from certain directions. [32].

**Advantages:**

- The signal strength grows stronger.
- High directivity can be achieved.
- The minor lobes are significantly reduced.
- There is a high signal-to-noise ratio.
- There is a significant gain.
- There is less power waste.
- Better results are obtained.

**Application:**

Satellite communications, Wireless communications, Radar communications, Astronomical research is an example of array antenna applications. The sorts of elements in an array can be characterized by their radiation patterns.

**Working of Array Antenna:** The Rayleigh criterion states that the angular breadth of the radio waves produced by an antenna, or its directivity, corresponds to the wavelength of the waves divided by the antenna's width. A directional antenna that beams radio signals in a restricted direction can be constructed using one of two general approaches. One way to alter the direction of radio waves is by using large metal surfaces like horns or conical mirrors to reflect them or by using dielectric optics to redirect them. utilizing a single low-gain antenna, into a beam. This form of antenna is called an aperture antenna. Parabolic dishes are an example of this type of antenna.

An array antenna, known as an antenna array, is a second method in which more antennas are joined by the same

transmitter or receiver. Due to the phenomena of interference, if the inputs are supplied to the antennas in the correct phase, the sphere waves from each individual antenna combine in front of the array to generate plane waves, a beam of electromagnetic radiation going in a particular direction. The power emitted increases as the waves from the several antennas combine when they arrive in phase.

**Design:** How to design the array antenna is given below step by step.

Step 1: Open CST microwave studio.

Step 2: Select a new project then mw/RF and Optical then select antennas then select planar (patch, slot) then select time domain.

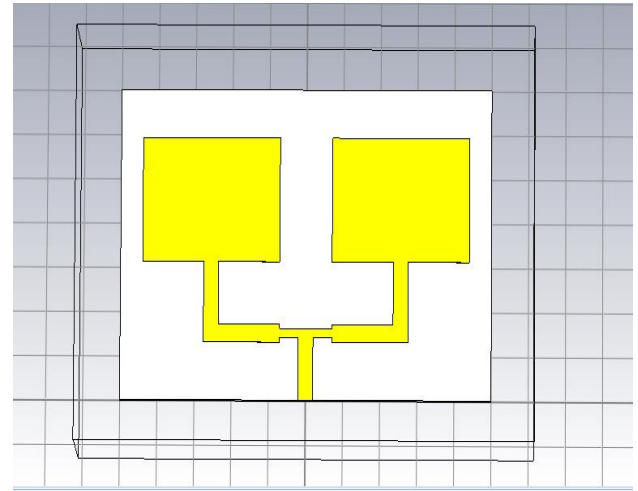
Step 3: Select a minimum and maximum frequency range and give a working frequency list then select all monitors like E-field, H-field, far-field, etc.

Step 4: Select modeling then select brick then press ESC and give the value as given below.

Name	Expression	Value	Description	Type
t	= 0.0335	0.0335	tebal conductor	Undefined
h	= 1.6	1.6	tebal dielectric/substrate t.junc...	Undefined
wf2	= 1.81	1.81	lebar t junction 70 ohm	Undefined
wf	= 4	4	lebar feed 50 ohm	Undefined
lf	= 14.12	14.12	panjang feed 50 ohm	Undefined
r	= 14.12	14.12	jarak antar patchpatch	Undefined
l	= 28	28	panjang patch	Undefined
w	= 37	37	lebar patch	Undefined
lg	= 70	70	panjang ground	Undefined
wg	= 100	100	lebar ground	Undefined

**Figure 27: Parameters of Array Antenna.**

Here we design a rectangular array antenna. Previously we designed rectangular and T-shape antennae, same as designed two rectangular antennae upper side of the substrate and downside T-shape antenna then by using Boolean add, we can add two antennas which made the array antenna.



**Figure 28: Array Antenna.**

### Simulation Output

Antenna simulation steps are given below.

Step 1: Calculate waveguide ports by macros function.

Step 2: Select the simulation then select pick face of the feed line then select the waveguide port option and give the value from the calculation.

Step 3: Select the simulation then select setup solver and set accuracy -40db, normalized to fixed Impedance 50ohm then press start.

Step 4: After completing the simulation double click far-fields and select the frequency which far-field want to show.

Step 5: Make a performance table at different frequencies which includes operating frequency, total efficiency, radiation efficiency, gain, and directivity.

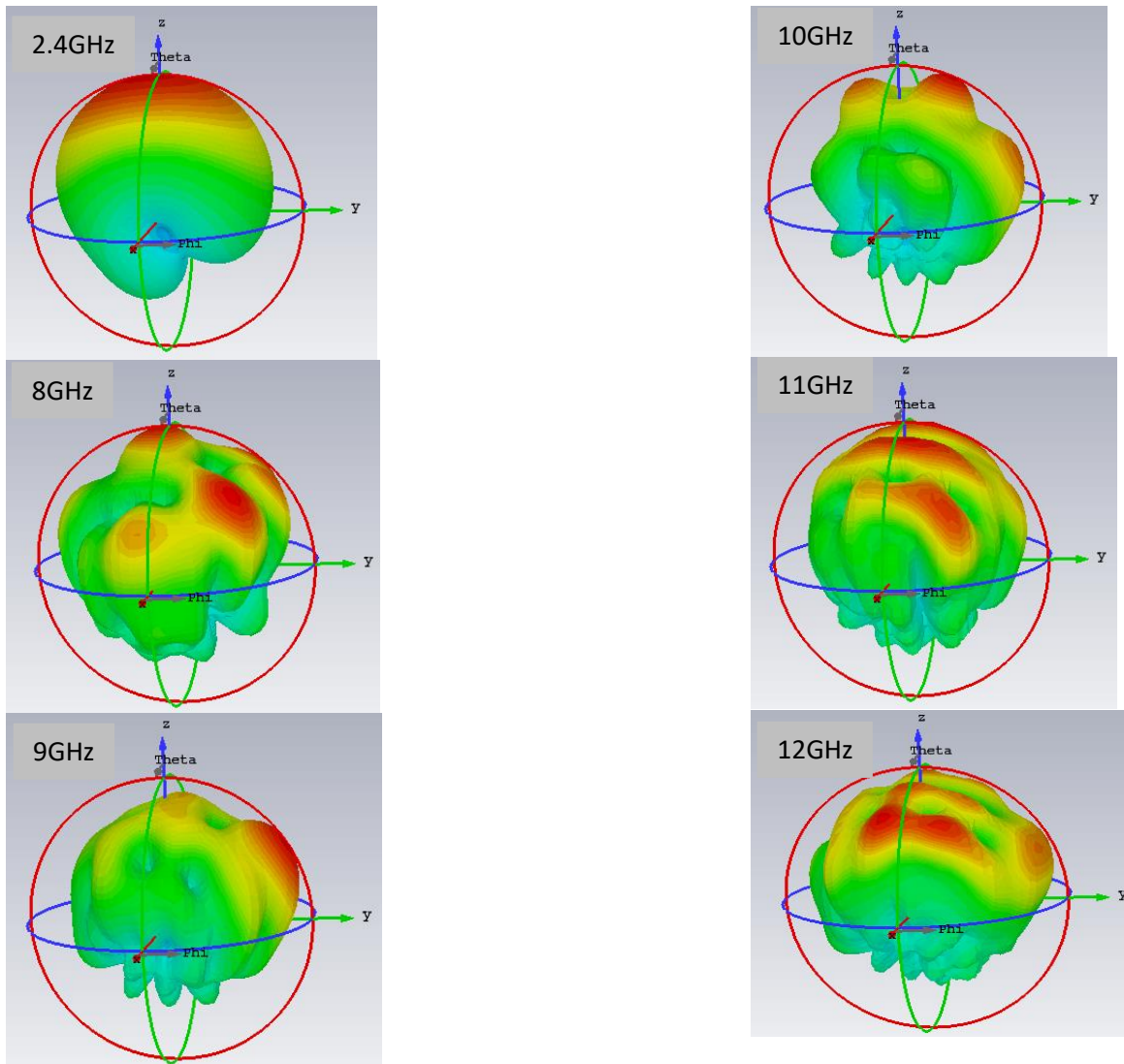
Step 6: To show S-parameter double click 1-D results then select S-parameter and to show bandwidth add curve marker at -10db points.

Step 7: To show VSWR double-click 1-D results and select VSWR option.

Step 8: To show the polar plot double click far-fields and select polar form.

Step 9: To show a 2-D plot double click Far-fields and select 2D.





**Figure 29: Array Antenna Far-fields at Different Frequencies.**

Frequency	Total efficiency	Radiation efficiency	Gain	Directivity
2.4GHz	-3.91dB	-3.54dB	4.70dB	8.24dbi
8GHz	-6.38dB	-6.14dB	1.48dB	7.63dBi
9GHz	-8.19dB	-5.98dB	4.73dB	10.72dBi
10GHz	-8.15dB	-5.94dB	6.10dB	12.05dBi
11GHz	-4.71dB	-4.69dB	3.32dB	8.01dBi
12GHz	-5.90dB	-4.05dB	3.43dB	7.48dBi

**Table 5: Performance Analysis of Array Antenna at Different Frequencies.**

S-Parameter:

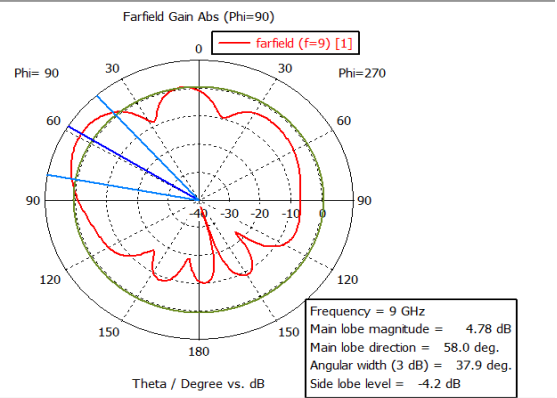
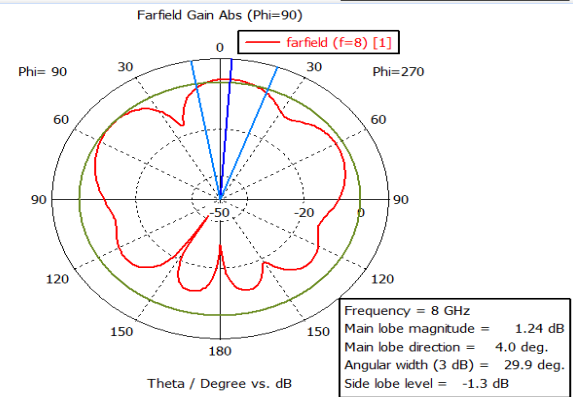
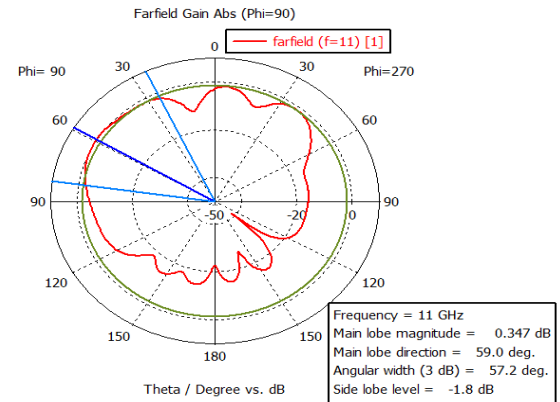
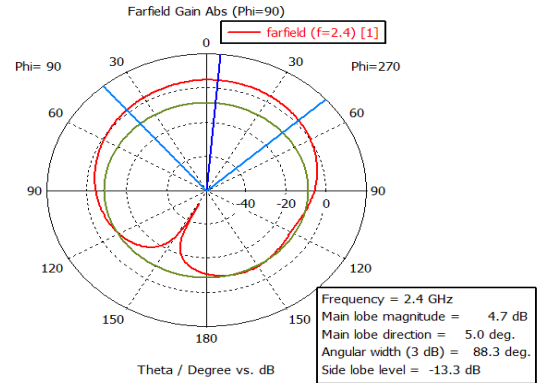
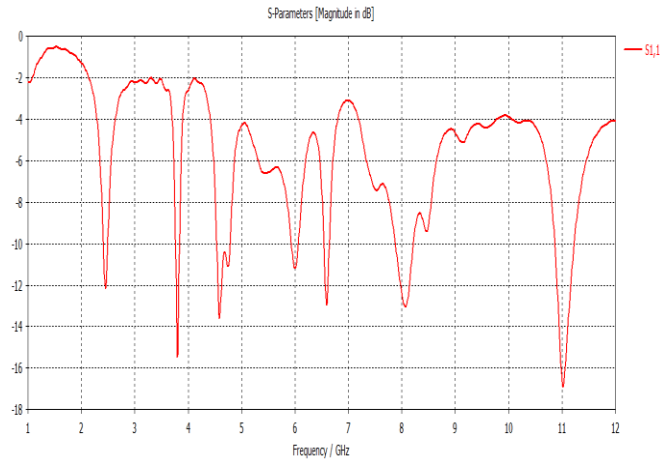


Figure 30: S-parameter at Different Frequencies of Array Antenna.

VSWR:

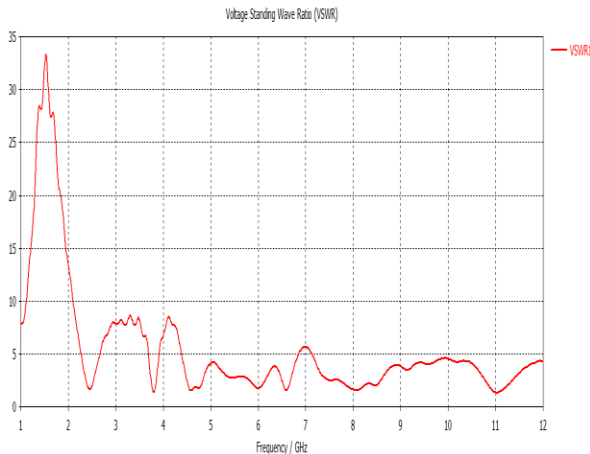
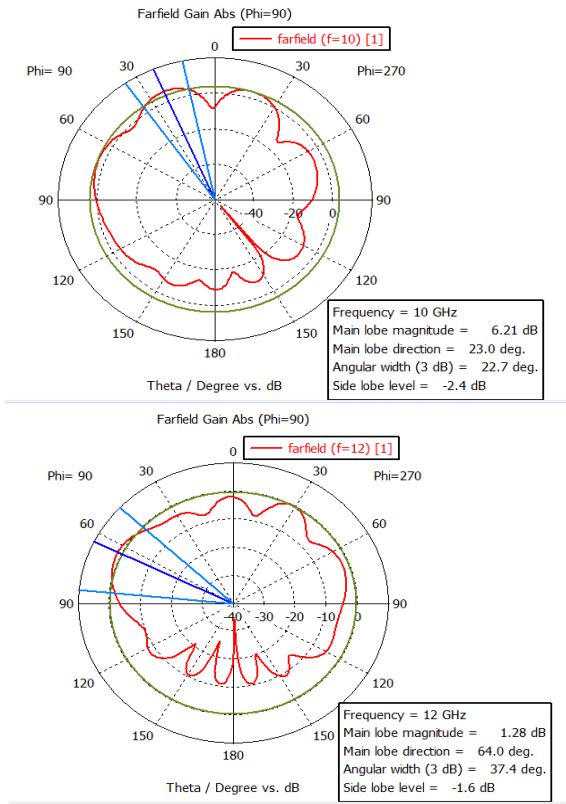


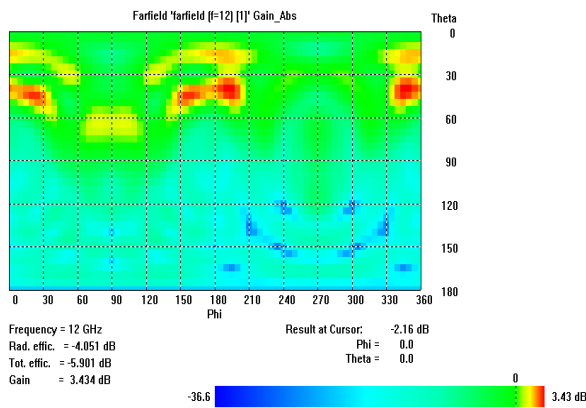
Figure 31: VSWR at Different Frequencies of Array Antenna.

Polar Plot:



**Figure 32: Polar Plot at Different Frequencies of Array Antenna.**

2-D plot:



**Figure 33: 2D Plot of Array Antenna.**

**T Shape patch antenna**

Transverse capacitive loading wires connected to the top of a monopole electromagnetic antenna define a T-antenna [33]. In the VLF, LF, MF, and shortwave bands, T-antennas are frequently employed as broadcasting antennas for

amateur radio stations as well as long-wave and medium-wave AM radio stations [34][35] [36]. Additionally, they can act as receiving antennas for shortwave listening. The antenna is composed of one or more insulation horizontal wires that are hung between two radio masts or buildings for reinforcement [33][36].

A vertical wire that passes through the center of the horizontal cables and swings low to the ground is attached to the transmitter or receiver. The name comes from the 'T' shape formed by the two halves. The bottom of the vertical wire and a ground connection are attached to the transmitter or receiver. The T-antenna is a top-loading monopole antenna. Other antennas in this category include the inverted L, umbrella, and triangle. Before 1920, it was invented during the early years of radio, during the wireless era. It functions as a transmitting antenna. The T-shaped microstrip patch antenna is intended to operate between 2 and 12 GHz.

The T-shaped antenna is tiny and flat, with a high gain. Ground structures are used to increase the antenna's bandwidth [37].

These constructions are created by etching rectangular grooves into the soil. Circular polarized between 2.5 and 9 GHz is produced by inserting four slits onto a square patch with a T-shaped slot; this frequency range is appropriate for WiMAX applications. Compared to earlier designs for circularly polarized antennas, this construction is smaller. Two frequencies are explored for radiation patterns: 2.5GHz and 9GHz. The antenna is simulated using the CST and VSWR. The simulated and observed data were contrasted at these frequencies.

**Antenna Design:**

How to design the T-Shape patch antenna is given below step by step.

Step 1: Open CST microwave studio.

Step 2: Select a new project then mw/RF and Optical then select antennas then select planar (patch, slot) then select time domain.

Step 3: Select the minimum and maximum frequency range and give a working frequency list then select all monitors like E-field, H-field, far-field, etc.

Step 4: Select modeling then select brick then press ESC and give the value as given below.

Figure 1 illustrates the schematic diagram of the proposed double T-shape patch antenna. As shown in Figure 1, a waveguide through the silver block is connected with the silicon block for feeding light into the antenna. The geometric parameters are as follows:

Ground: l = 30 nm, w = 45 nm, h = .3 nm,

Substrate: same as ground

Component 1: Uaxis:-1/2 to 1/2, Vaxis: 12nm-18nm , Waxis:0.3nm

Component 2: Uaxis: -1/3 to 1/3, Vaxis: 4nm-9nm , Waxis: 0.3nm

Component 3: Uaxis: -2.5 to 2.5, Vaxis:-w/2-4nm, Waxis: 0.3nm

Component4: Uaxis: -2.5 to 2.5, Vaxis: 9-12nm, Waxis: 0.3nm

Component5: Uaxis: -1/2 to -3.5, Vaxis: -h/2-3nm , Waxis: 0.3nm

Component6: Uaxis: 3.2 to 1/2, Vaxis: -h/2-3nm , Waxis: 0.3nm

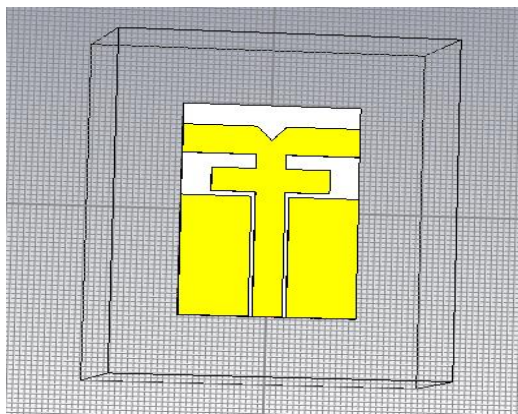


Figure 34: T-shape Antenna.

For simulation, a beam of light with TE polarization (x-polarization) is fed into the T-shape antenna via the silicon waveguide. At the frequency of 2.4 GHz, the material properties are shown in the below figure.

Component 1:solid 1	
Material	Copper (annealed)
Type	Lossy metal
Mu	1
Electric cond.	5.8e+07 [S/m]
Rho	8930 [kg/m^3]
Thermal cond.	401 [W/K/m]
Heat capacity	0.39 [kJ/K/kg]
Diffusivity	0.000115141 [m^2/s]
Young's modulus	120 [kN/mm^2]
Poisson's ratio	0.33
Thermal expan.	17 [1e-6/K]

Figure 35: Component Values of T shape.

### Simulation Output

Antenna simulation steps are given below.

Step 1: Calculate waveguide ports by macros function.

Step 2: Select the simulation select the pick face of the feed line then select the waveguide port option and give the value from the calculation.

Step 3: Select simulation then select setup solver and set accuracy -40db, normalized to fixed Impedance 50ohm then press start.

Step 4: After completing the simulation double click far-fields and select the frequency which far-fields want to show.

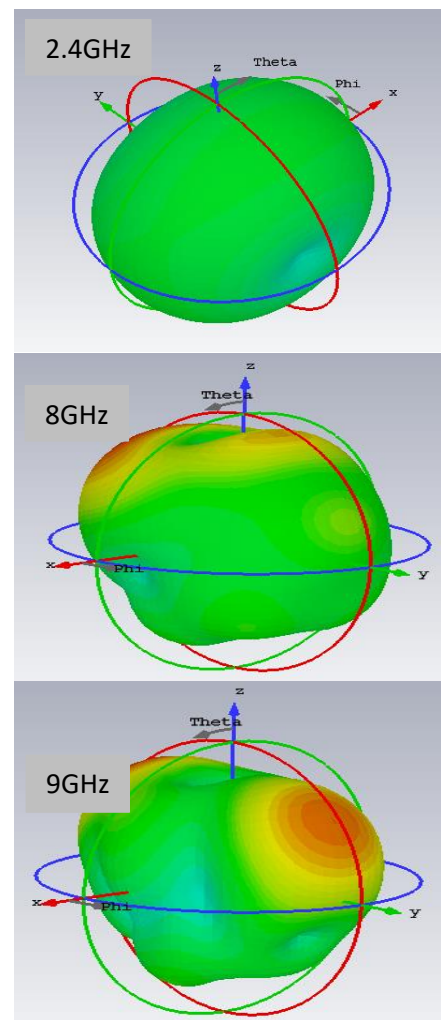
Step 5: Make a performance table at different frequencies which includes operating frequency, total efficiency, radiation efficiency, gain, and directivity.

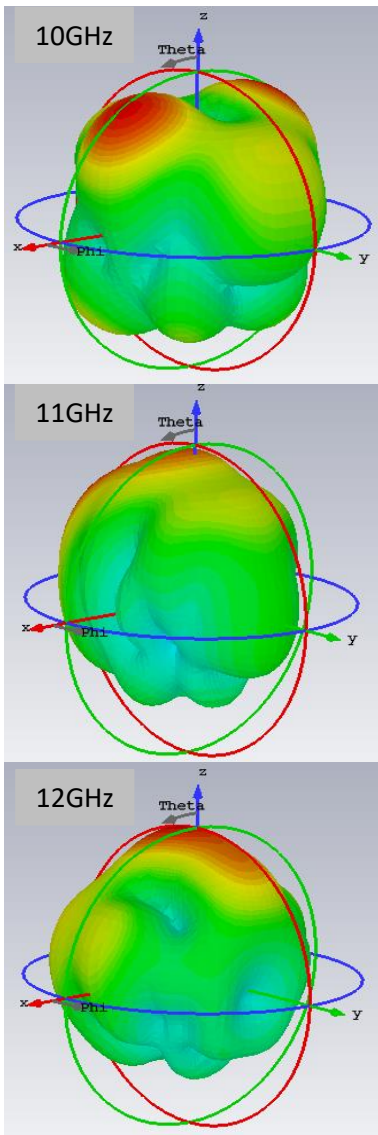
Step 6: To show S-parameter double click 1-D results then select S-parameter and to show bandwidth add curve marker at -10db points.

Step 7: To show the VSWR double-click 1-D results and select the VSWR option.

Step 8: To show the polar plot double click far-fields and select polar form.

Step 9: To show a 2-D plot double click Far-fields and select 2D.



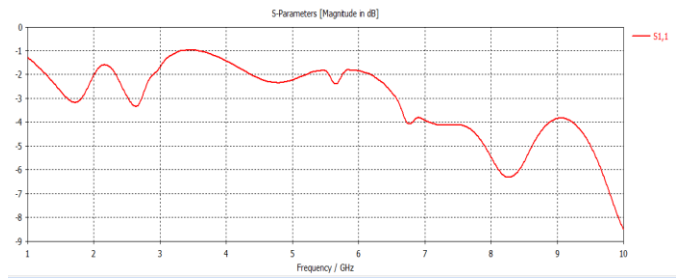


**Figure 36: T Shape Antenna Far-fields Radiation Pattern at Different Frequencies.**

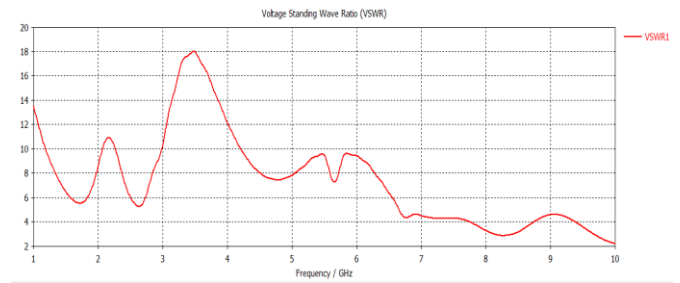
The performance table is given below.

Frequency	Total efficiency	Radiation efficiency	Gain	Directivity
2.4GHz	-28.26dB	-24.50 dB	-20.98dB	3.52dBi
8 GHz	-15.70dB	-14.18dB	-7.79dB	6.21dBi
9 GHz	-16.34dB	-14.03dB	-6.33dB	7.69dBi
10 GHz	-15.39dB	-14.68dB	-7.35dB	7.32dBi
11 GHz	-8.94dB	-8.52dB	0.368dB	8.89dBi
12 GHz	-7.78dB	-7.47dB	1.01dB	8.47dBi

**Table 6: T Shape Output Performance Analysis at Different Frequencies.**

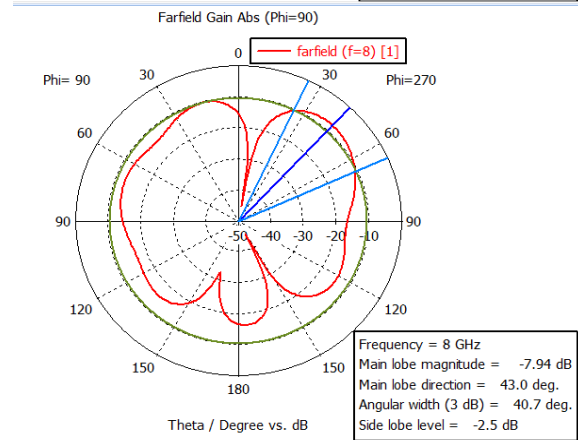
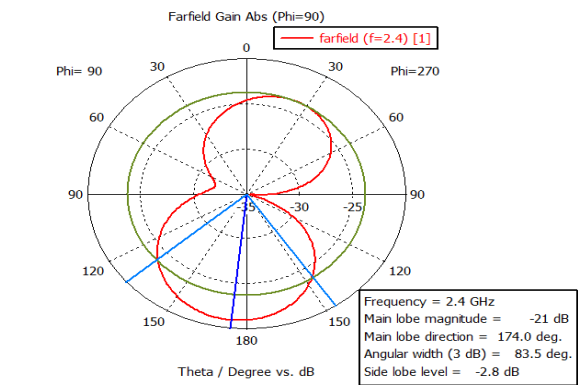


**Figure 37: S-parameter of T Shape.**



**Figure 38: VSWR of T Shape.**

Polar plot:



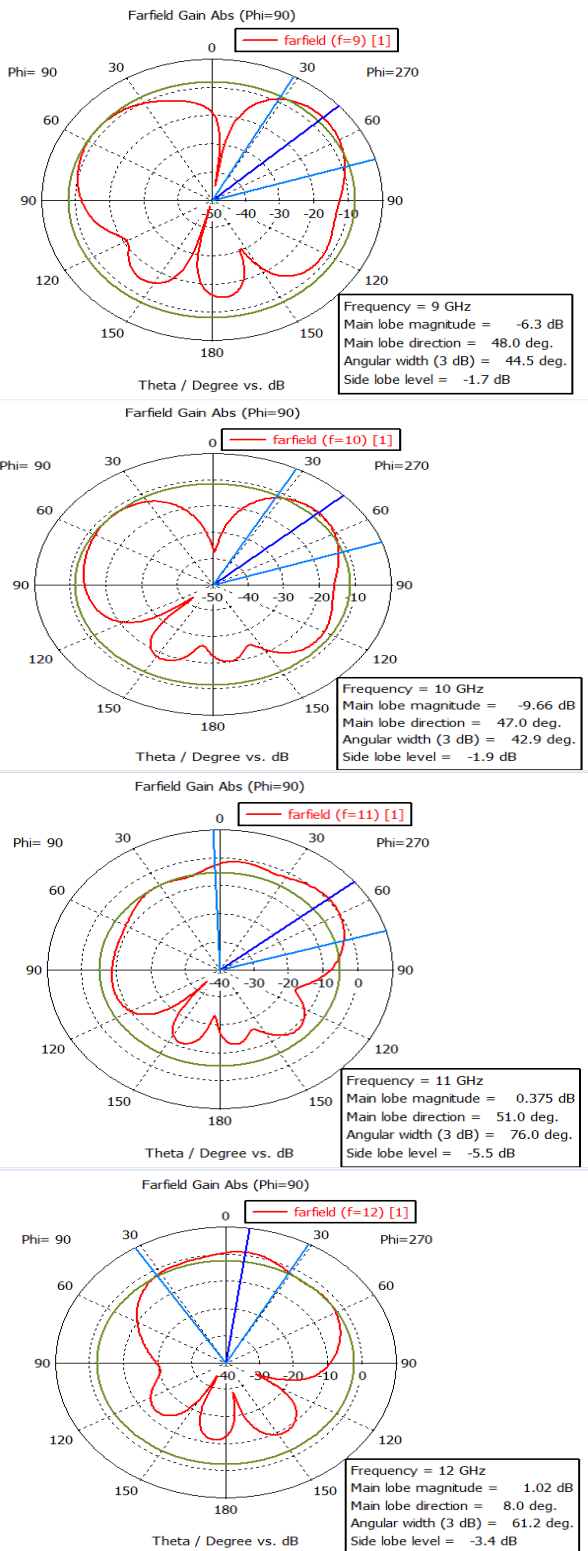


Figure 39: Polar Plot at Different Frequencies of T shape.

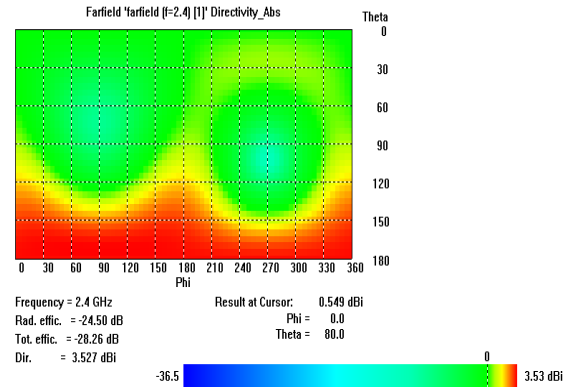


Figure 40: 2D Plot of T shape.

## 6. Expected Outcomes and Contribution of the Research

The software has been implemented. We have used CST microwave tools software to implement this proposed model and achieve good results. Our utmost effort has been made to achieve optimum accuracy. In this study, we examined the results of Gain, Directivity, S-parameter, VSWR, polar plot, and 2D plot. The Rectangular microstrip patch antenna was the top performer in our analysis. It is suitable for operation at 2.4GHz. At 2.4 GHz, the total efficiency is -3.90dB, with a radiation efficiency of -3.33dB, a gain of 4.37dB, and a directivity of 7.71dBi. The frequency directivity at 9GHz, 10GHz, and 11GHz is good, but gain and radiation efficiency are low, as shown in the analysis table. The bandwidth is 2.35-2.42GHz, according to the S-parameter. The circular antenna was the second antenna. It works well at a frequency of 10GHz. Total efficiency is -4.27dB, radiation efficiency is -3.72dB, gain is 2.69dB, and directivity is 6.41dBi at this frequency.

The dipole antenna is the third option. The total efficiency is -0.41dB, the radiation efficiency is -0.31dB, the gain is 2.08dB, and the directivity is 2.11dB at 1GHz. The gain and directivity are higher at other frequencies, but the radiation efficiency is much lower. The bandwidth is 0.12GHz according to the S-parameter.

The array antenna is the fourth. The 2.4GHz frequency is ideal. The total efficiency is -3.91dB, the radiation efficiency is -3.54dB, the gain is 4.70dB, and the directivity is 8.24dBi, according to the array antenna performance table at 2.4 GHz frequency. The directivity is 12.05dBi and the gain is 6.10dB at 10GHz, yet the radiation efficiency is lower than the overall efficiency. And at 11GHz the gain and directivity are also good.

The last one is a microstrip patch antenna with a double T. The system operates effectively at a 12GHz frequency. The overall efficiency at 12 GHz, as indicated in the performance analysis table, is -7.78dB, with a higher radiation efficiency of -7.47dB compared to other frequencies. It has a gain of 1.01dB and a directivity of 8.47dBi, both of which surpass those of other frequencies.

Each antenna also features polar plots, S-parameters, and 2D plots. The antennas are constructed using FR-4 lossy copper-coated substrate material with a dielectric constant of 4.4 and a thickness of 1.5 mm. The feeding mechanism employed is a microstrip 50 feed line.

## 7. Future Work

The potential for enhancement is substantial, with the opportunity to extend the component and design to incorporate antennas. Enhancements can involve the utilization of various antenna types, including MIMO antennas, operating at increased frequencies. This advancement will enable the detection of tumors or cancer cells, such as brain tumors, in the future. Additionally, antennas can be developed for WiFi, WiMAX, and satellite communication systems.

## 8. Conclusion

We first thanked Allah, the Almighty. Completing it was not easy. We first learn about CST microwave tools in this section. We learn how to construct antennas and simulate antennas by using these tools. Antenna is currently a research area in the field of communication. Finally, we completed our work on "Analyzing the performance of several antennas in comparison". Some difficulties with the device's operation were encountered when doing the task. Many software functions and calculations have been incorporated into our work that are commonly used and will aid in efficient analysis. We have put in maximum effort to ensure the highest level of accuracy. In this study, we conducted comparisons of Gain, Directivity, S-parameter, VSWR, polar plot, and 2D plot. Five types of antennas are discussed in this paper: the Rectangular microstrip patch antenna, circular patch antenna, dipole antenna, array antenna, and double T shape microstrip patch antenna. The rectangular antenna operates at 2.4GHz, the circular antenna at 10GHz, the Dipole at 10GHz, the Array antenna at 2.4GHz, and the double T shape antenna at 12GHz. There will be numerous opportunities for future work on antennas.

## 9. References:

- [1] V. Thakur and S. Kashyap, "A Review Paper on Techniques and Design for Microstrip Patch Antenna", *Int. J. Adv. Res. Electr. Electron. Instrum. Eng.*, vol. 4, no. 2, pp. 656–662, 2015.
- [2] S. Bisht, S. Saini, V. Prakash, and B. Nautiyal, "Study the Various Feeding Techniques of Microstrip Antenna Using Design and Simulation Using CST Microwave Studio", *Int. J. Emerg. Technol. Adv. Eng.*, vol. 4, no. 9, pp. 318–324, 2014.
- [3] T. Ferdous, A. Nayna, and F. Ahmed, "Comparative Study of Rectangular and Circular Microstrip Patch Antennas in X Band", *Int. Conf. Electr. Eng., Inf. Commun. Technol.*, 2014.
- [4] P. Mane, S. A. Patil, and P. C. Dhanawade, "Comparative Study of Microstrip Antenna for Different Substrate Material at Different Frequencies", *Int. J. Emerg. Eng. Res. Technol.*, vol. 2, no. 9, pp. 18–23, 2014.
- [5] I. Singh and V. S. Tripathi, "Microstrip Patch Antenna and its Applications" Indrasen Singh al., *Int. J. Comp. Tech. Appl.*, vol. 2, no. 5, pp. 1595–1599, 2011.
- [6] S. Tilekar, "Comparative Study of Rectangular, Square, Circular, and Meander Patch Microstrip Antenna," *Int. J. Electr. Electron. Data Commun*, no. 1, pp. 106–109, 2015.
- [7] J. A. Navarro, K. Chang, J. Tolleson, S. Sanzgeri, T. Instruments, "Design for a Circular Patch Antenna Fed by an Aperture Coupled Microstrip Line. To Improve The Performance, a Cavity Surrounds the Patch to Reduce the Surface Wave Interactions in an Array Environment and Improve Heat Dissipation for Active Devices", *Antennas Propag. Soc. Symp. 1991 Dig. London, Ontario, Canada*, vol. 2, pp. 1094–1097, 1991.
- [8] S. Shrivastava and A. Bhargava, "A Comparative Study of Different Shaped Patch Antennas with and Without Slots", *Int. J. Eng. Dev. Res.*, vol. 2, no. 3, pp. 3306–3312, 2014.
- [9] R. Khan, T. Jamal, M. I. Aslam, I. Ahmed, and E. Technologies, "Comparative Analysis of

- Different Patch Antennas**", 1<sup>st</sup> International Electr. Eng. Congr, no. IEEC, 2016.
- [10] A. Khidre, S. Member, K. Lee, F. Yang, S. Member, and A. Z. Elsherbeni, "Circular Polarization Reconfigurable Wideband E - Shaped Patch Antenna for Wireless Applications", *IEEE Trans. Antennas Propag.*, no. c, pp. 1-5, 2011
- [11] Tao Dong, Yue Xu, and Jingwen He "Plasmonic Nanoantenna Array Design, Nanoplasmonics", *Carlos J. Bueno-Alejo, Intech Open*, pp.1-5(January 4th, 2020).
- [12] W. A. E. Ali, E. K. I. Hamad, M. A. Bassiuny and M. Z. M. Hamdalla "Complementary Split Ring Resonator Based Triple Band Microstrip Antenna for WLAN/WiMAX Applications", 1<sup>st</sup> International Electr. Eng. Congr, no. IEEC, 2016.
- [13] C. Şeker and M. T. Güneşer, "Design and Simulation of 26 GHz Patch Antenna for 5G Mobile Handset", 11th International Conference on Electrical and Electronics Engineering (ELECO), 2019, pp. 676-678, doi: 10.23919/ELECO47770.2019.8990634.
- [14] H. G. Akhavan and D. M. Syahkal, "Study of Coupled Slot Antennas Fed by Microstrip Lines", 10th International Conference on Antennas and Propagation, Edinburgh, UK, vol. 1, pp. 1290-1292, 1997.
- [15] R. Vaughan and J. B. Anderson, Channels, "Propagation and Antennas for Mobile Communications", *IEEE, London*, 2003.
- [16] Tansarıkaya, "Geniş Bandlı Yama Antenna Tasarımı (Doctoral dissertation)", *Fen Bilimleri Enstitüsü* 2007.
- [17] Wa'il, A., Shaaban, R. M., & Duffy, A. P. "Design, Simulation, and Fabrication of a Double annular Ring Microstrip Antenna Based on Gaps with Multiband Feature", *Engineering Science and Technology, an International Journal* 2021.
- [18] Acıkaya, F. C., & Yıldırım, B. S, "A Dual-Band Microstrip Patch Antenna for 2.45/5-GHz WLAN Applications", *AEU-International Journal of Electronics and Communications*, 2021,p. 141, 153957.
- [19] Wa'il, A., Shaaban, R. M., & Tahir, A., "Design, Simulation and Measurement of Triple Band Annular ring Microstrip Antenna Based on Shape of Crescent Moon", *AEU-International Journal of Electronics and Communications*, 2021,p.117, 153133
- [20] Shera Prabjyot Singh, Ashish Singh, Deepak Upadhyay, Sunilkumar Pal, Mahesh Munde, "Design and Fabrication of Microstrip Patch Antenna at 2.4 GHz for WLAN Application using HFSS", *IOSR Journal of Electronics and Communication Engineering (IOSR-JECE) Special issue AETM'16 Volume No. 1*.
- [21] B.Sai Sandeep; S.Sreenath Kashyap, "Design and Simulation of Microstrip Patch Array antenna for Wireless Communication at 2.4 GHz", *International Journal of Scientific & Engineering Research*, Volume 3, Issue 11, November 2012.
- [22] Winder, Steve; Carr, Joseph, "Newnes Radio and RF Engineering Pocket Book" (3rd ed.2002). Newnes. p. 4. ISBN 0080497470.
- [23] Acıkaya, F. C., & Yıldırım, B. S, "A Dual-Band Microstrip Patch Antenna for 2.45/5-GHz WLAN applications", *AEU-International Journal of Electronics and Communications*,2002,p. 141, 153957.
- [24] Basu, Dipak, "Dictionary of Pure and Applied Physics (2nd ed.)",*CRC Press*. 2010, p. 21. ISBN 978-1420050226.
- [25] Bodnar, Donald, ANSI/IEEE Std 145-1993 IEEE "Standard Definitions of Terms for Antennas", *New York, NY: The Institute of Electrical and Electronics Engineers, Inc.*1993, pp. 10,2,102
- [26] "Dipole Antenna / Aerial tutorial", *Resources. Radio-Electronics.com. Adrio Communications, Ltd*. 2011. Retrieved 29 April 2013.
- [27] Rouse, Margaret, "Dipole Antenna". *Online IT Encyclopedia. whatis.techtarget.com*. Retrieved 29 April 2013.
- [28] Balanis, Constantine A, "Modern Antenna Handbook. John Wiley & Sons". p. 2.3. ISBN 978-1118209752.



- [29] Balanis, Constantine A. (2011), "**Modern Antenna Handbook**. John Wiley and Sons", pp. 2-1. ISBN 978-1118209752.
- [30] Stutzman, Warren L.; Thiele, Gary A., "**Antenna Theory and Design**", John Wiley and Sons, 2012 pp. 74-75. ISBN 978-0470576649.
- [31] Poole, Ian, "**What is MIMO? Multiple Input Multiple Output Tutorial**", *Antennas and propagation. Radio-electronics Communications*. Retrieved February 23, 2017.
- [32] Bevelacqua, Peter, "**Array Antennas**", *Antenna-theory.com*. Retrieved February 23, 2017.
- [33] Graf, Rudolf F, "**Modern Dictionary of Electronics**", 7th Ed. USA: Newnes. 1999 p. 761. ISBN 0-7506-9866-7
- [34] Chatterjee, Rajeswari, "**Antenna Theory and Practice, 2nd Ed**". New Delhi: New Age International, 2006 pp. 243-244. ISBN 81-224-0881-8
- [35] Rudge, Alan W, "**The Handbook of Antenna Design**", Vol. 2. IET. 1993 pp. 554, 578-579. ISBN 0-906048-87-7
- [36] Edwards, R.J. G4FGQ, "**The Simple Tee Antenna**", *Antenna design library*. Retrieved 23 February 2012.
- [37] Straw, R. Dean, "**The ARRL Antenna Book (19th ed.)**" USA: American Radio Relay League. 2006 pp. 6-36. ISBN 0-87259-817-9