

Investigation and Control Strategies of Three Level DCI For Power Quality Issues In Solar PV Grid Connected System

Hariom Narware¹, Dr. E Vijay Kumar²

Department of Electrical Engineering,
RKDF IST, SRK University, Bhopal. M.P, India

Abstract: The continuous supply of clean electrical power has become essential to modern civilization. However, the grid and transmission network may not always deliver clean and reliable power. Understanding the variety of power quality problems in the received supply and thenature of the loads is the first approach to the power quality solution. In this paper performance of the diode clamped three-level inverter (DC-TLI) using simulation and hardware is evaluated. Performance evaluated for power quality of three-level diode clamped SPWM Voltage source inverter. FFT (Fast Fourier Transform) graph for DC-TLI and line current THD (Total Harmonic Distortion) values is compared with two-level inverter line voltage and current. MLIs (multilevel inverters) are utilized to increase the number of steps to produce high quality output waveforms. MLIs are used to eliminate harmonics and increase the inverter's performance.

Keywords: Power Quality, Solar PV Grid, Diode Clamped Three-Level Inverter, Photovoltaic, Grid-connected, renewable energy.

1 Introduction

The grid power quality is affected by the rising penetration of grid- connected renewable energy sources. Major power quality challenges include harmonics, frequency variation, and voltage fluctuation. Multi- level inverters are extensively employed in grid-tied PV systems because of their characterized by lower cost and higher efficiency. Owing to the extensive use of nonlinear power electronics loads, ac distribution networks have suffered significant harmonic pollution. Nonlinear loads like lamp ballasts, motors drives, electric welding equipment, arc furnaces, electronics battery chargers, etc. Harmonic standards and guidelines, such as IEEE-519-1992 and IEC 61000, govern best practices in power system and nonlinear equipment design[1]. Many strategies can be used to improve the power quality of inverters. This research develops a system that incorporates a three-level neutral point clamped (3L-NPC) inverter with a control strategy that keeps the necessary voltages for the input DC bus voltage of a grid-tied three-phase PV system [3]. The multilevel inverter (MLI) for solar inverter systems improves through increased rating and improving performance and efficiency. The rating of MLI is increased by adding more voltage levels without increasing individual device ratings, and the output voltage's harmonics are decreased. The three topologies of MLIs are: (1) Cascade H-bridge Multilevel

Inverter (CHBMLI), (2) Flying Capacitor Multilevel Inverter (FCMLI), and (3) Diode Clamped Multilevel Inverter (DCMLI) [2]. For power quality enhancement, the researchers have consistently used, modified, tested, and implemented various MLI configurations for a wide range of applications for medium/high power and medium/high voltage systems[3][4]. Harmonics must be restricted to a specific level, according to the IEEE standard; otherwise, the core of power transformer may be saturated. Harmonics might be restricted in this scenario in two ways: on the load side or the source side. A power conditioner is commonly connected across the load at the point of common coupling (PCC). Precision inverter and controller design gives control over harmonics at source side [5][6]. A general SVPWM algorithm is proposed for three-level inverter [5][7]. Inverter control and output voltage with losses are described[8]. Solar fed multilevel inverter power quality improvement is discussed [9]. Reactive

2. Proposed system

Before you begin to format your paper, first write and save the content as a separate text file. Keep your text and graphic files separate until after the text has been formatted and styled. Do not use hard tabs, and limit use of hard returns to only one return at the end of a paragraph. Do not add any kind of pagination anywhere in the paper. Do not number text heads-the template will do that for you.

Finally, complete content and organizational editing before formatting. Please take note of the following items when proofreading spelling and grammar:

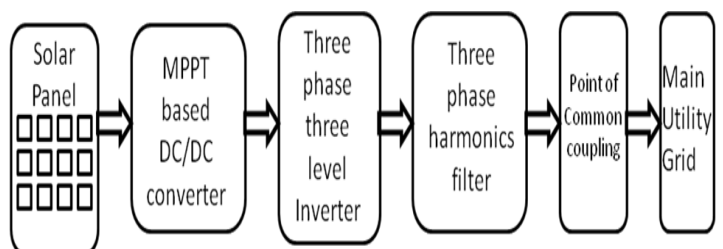

Figure 1 Block diagram for solar PV grid integration

The proposed solar PV grid integration block diagram is exposed in Figure

1. The system blocks represent (1) Solar panel (2) MPPT DC to DC boost converter (3) NPC three-level three phase inverter

(4) three phase harmonics filter (5) main utility grid. Among the three topologies of MLIs, DCMLI is introduced. The output power is integrated with grid after the harmonics filter is used. The DC to AC converter use to convert DC in to AC. The MPPT control strategy is applied to the boost converter. The DC link voltage is controlled using constant voltage control mode. After applying the DQ transformation to DC to AC converter, the decoupling control structure calculates the three phase voltage to generate correct ac without harmonics. The DC-TLI output is synchronised with the main grid using phase locked loop (PLL) [3]. It transfers the required amount of power to the grid as per the load requisite. The switching operation of the inverter is determined by the SPWM control [11].

Sample paragraph, The entire document should be in cambria font. Type 3 fonts must not be used. Other font types may be used if needed for special purposes. The entire document should be in cambria font. Type 3 fonts must not be used. Other font types may be used if needed for special purposes.

3. Simulation results

This paper presents a modelling and simulation work of grid connected three-level diode clamped SPWM inverter. MPPT controller used in PV grid system to get optimum output. The DC link voltage is connected with the DC-TLI and the output of the inverter is synchronized with the main grid. The inverter maintains the voltage and frequency equal to the grid voltage and frequency [11][12]. SIMULINK block sets in MATLAB are used for the simulation study.

The effectiveness of the suggested topology and control algorithm is tested and presented using simulation results. The simulation is done for the input value of solar irradiance is 1000 KW/m². SPWM scheme for implementation of twelve pulse generation for three-level diode clamped inverter is proposed as in Figure 3. Simulation parameters are shown in Table 1 used for DC-TLI. Figure 4 exhibits the results of SPWM gate pulse generation for DC-TLI.

Table 1. Inverter simulation parameters

Sr. No.	Parameter used in simulation	Values
1	Carrier Frequency	8000 Hz
2	Modulation Index	0.8
3	Output Voltage Frequency	50 Hz
4	Sample Time	50 e -6 S

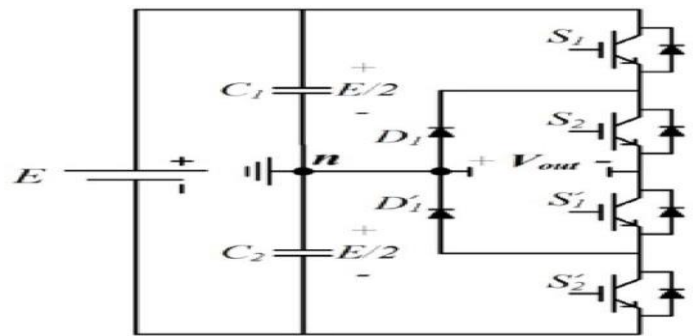

Figure 2. One leg configuration of SPWM DC-TLI

The frequency modulating index (M_f) and amplitude modulation index (M_a) are two important parameters to decide control of SPWM.

$$M_a = V_m / V_c$$

Where, V_m = amplitude of modulating wave, V_c = amplitude of carrier wave

$$M_f = f_c / f_m$$

Where, f_c = frequency of carrier wave, f_m = frequency of modulating wave

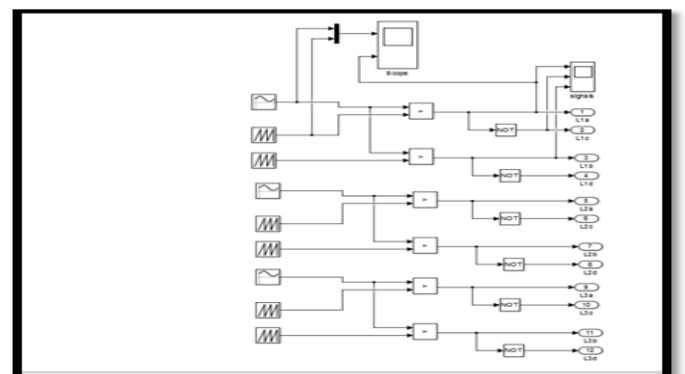

Figure 3. SPWM Scheme implementation for twelve pulse generator for DC-TLI

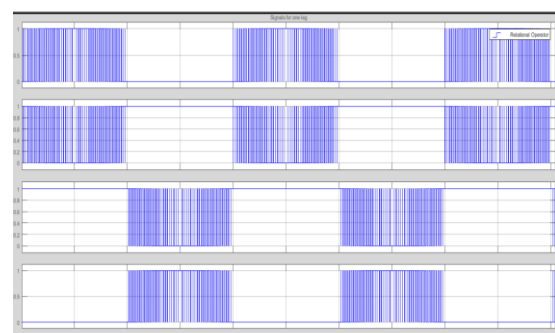

Figure 4. Gate pulses for one leg of SPWM DC-TLI

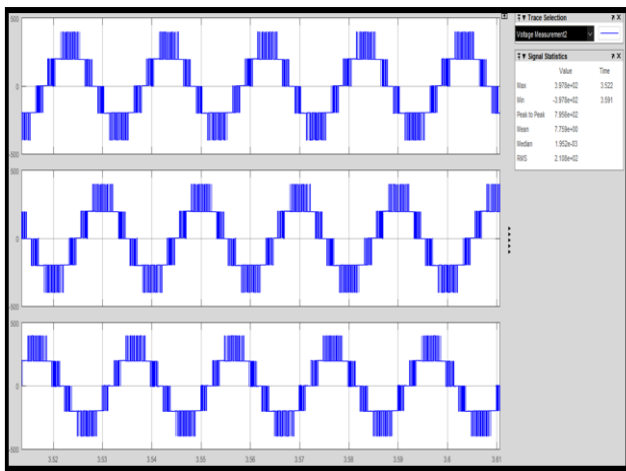

Figure 5. Line voltages of SPWM DC-TLI

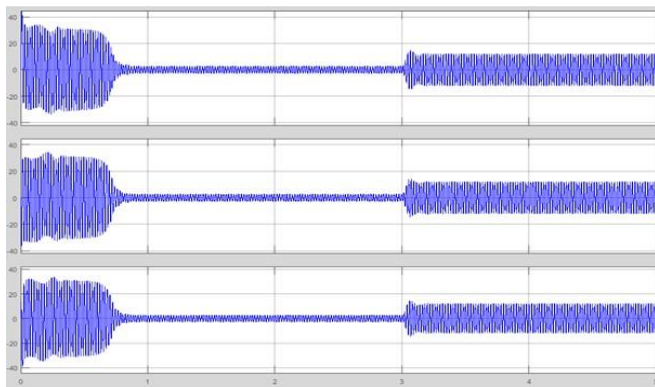

Figure 6 Line current of SPWM DC-TLI for different loading condition

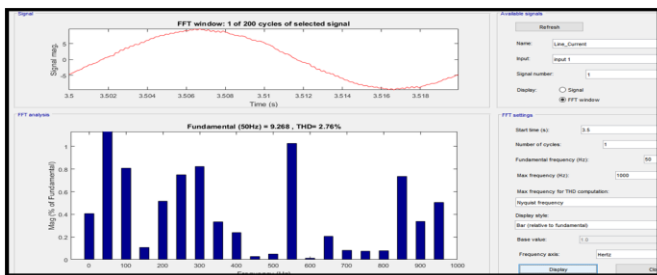

Figure 7. FFT graph for DC-TLI line current (rms)= 6.55 A and THD value = 2.76%

FFT Graph For DC-TLI line current (rms) of 6.55 A is shown in Figure

7. FFT Graph For two-level inverter Line current (rms) = 7A is shown in Figure 9.

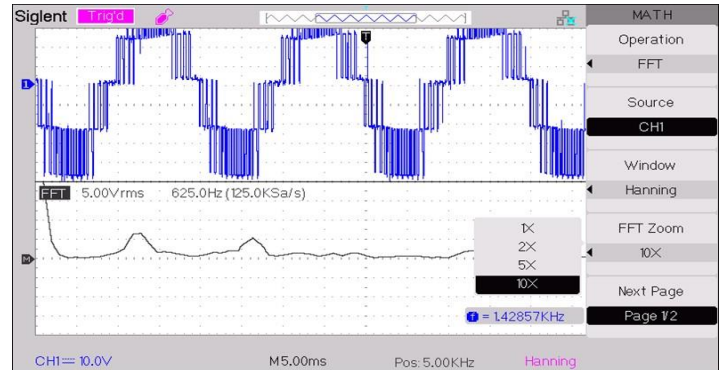

Figure 9. FFT graph for two-level inverter line current (rms) = 7A and THD Value = 10.87%

Table 2. Comparison of power quality in line current on form of THD

Inverter type	Line current (rms)	THD
Two-level Three phase SPWM inverter for RL Load	7A	10.87%
DC-TLI SPWM inverter for RL Load	6.55A	2.76%

4. Hardware results on DC-TLI SPWM Inverter (prototype)

The practical set up as shown in Figure 9 used to validate the solar powered DC-TLI for grid connection. The rating as simulation results with DC-TLI is presented in hardware also. Power rating is scaled to the following rating due to hardware availability.

- Inverter Input DC voltage 48V
- Maximum inverter output AC phase voltage (V_{ph}) : 20 V

Maximum inverter output AC line voltage (V_{L-L}) : 34

Figure 8 shows the gate pulse of S1 and S1' and Figure

11 shows the gate pulse of S1 and S4'.The waveform of line voltage (VRY) is presented in Figure 12. Figure 13 shows FFT Graph for the line voltage waveform. Figure 14 shows for the three-level NPC inverter module phase voltage waveform.

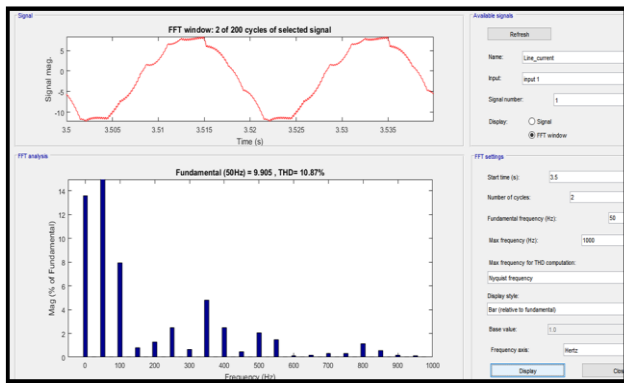

Figure 9. Gate pulse of S1 and S1' for DC-TLI

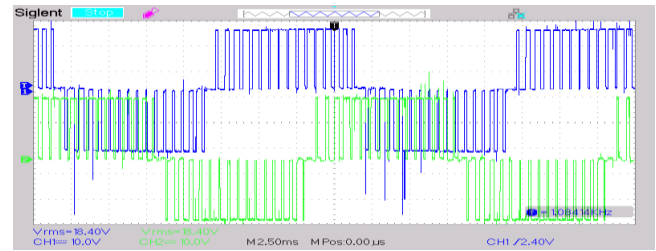

Figure 12. The waveform of phase voltages for DC-TLI

The Resistive (R) Load and Inductive (RL) Load connected with DC-TLI are experimentally checked. Resistive (R) Load of 200 ohm, 25 W is connected and experimentally checked as shown in Figure 15. Inductive (RL) Load of (R= 200 ohm, 25W, L=120mH each phase) is connected and experimentally checked as shown in Figure 16. The THD of line current is improved seen in practical testing.

Figure 13. Load Current in case of Resistive Load (R= 200 Ohm, 25 W) and FFT graph for DC-TLI

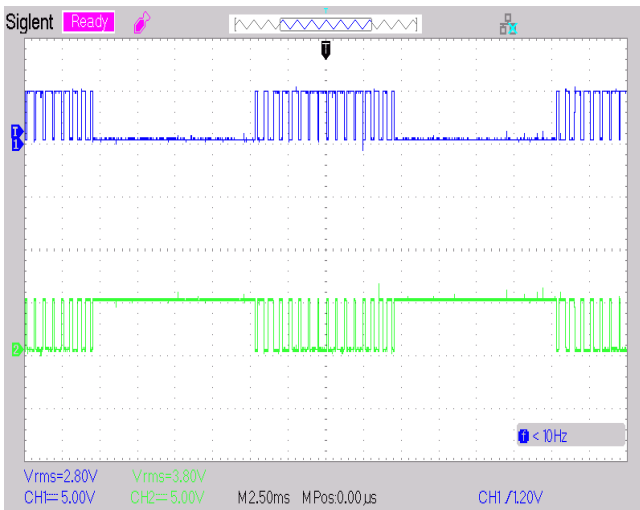

Figure 10. Gate pulse of S1 and S4' for DC-TLI

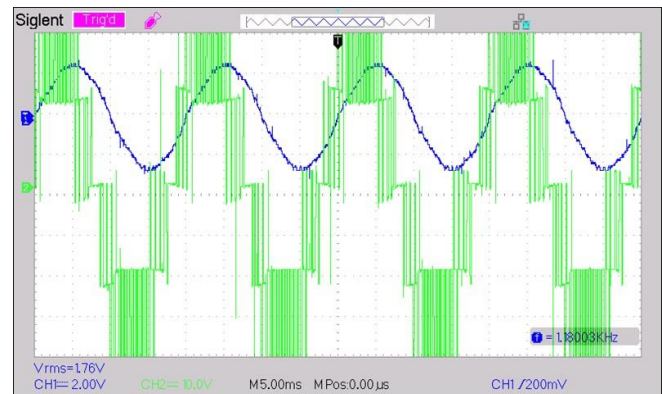

Figure 14. DC-TLI waveform of Voltage (VRY) and current (IR) with RL Load (IL=0.3A, VL=34V)

Figure 17. Waveform of RL Load Current and FFT window graph for DC-TLI.

4. Conclusion

This paper presented a comparison between traditional two-level inverter and DC-TLI for power quality of solar PV systems. Power quality with respect to THD and Harmonic distortion is analysed for DC-TLI module for the solar PV grid. Simulation results of Three-level diode clamped

SPWM VSI simulation using MATLAB are presented. FFT graph and THD values are compared for DC-TLI with two-level inverter line current. The 3-level diode clamped inverter improves THD up to 2.72% to 2-level conventional inverter THD is about 10.87 %. DC-TLI requires only six diode for clamping. As voltage level increases, clamping diode requirement also increases. Three-level inverters (TLIs) are used to eliminate harmonics and hence the performance of inverter system of the solar PV grid is improved.

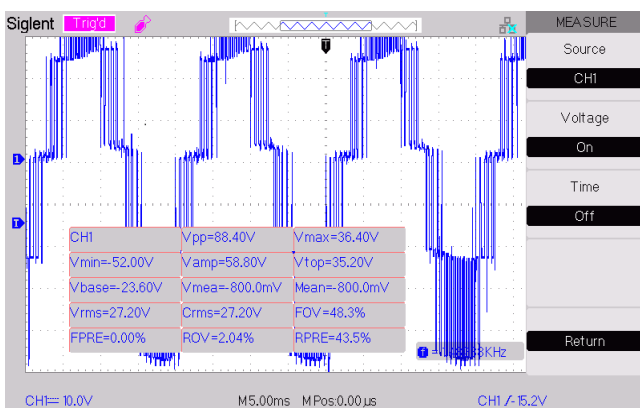

Figure 11. Waveform of line voltage VRY for DC-TLI

Reference:

- [1] S. Kumar and C. Sethuraman, "Grid tied inverters for renewable energy systems - a review," *International Journal of Environment and Sustainable Development*, vol. 21, no. 1-2, pp. 43-75, 2022.
- [2] M. V Subramanyam, B. P. Reddy, and P. V. N. Prasad, "THD Analysis for 3-Phase 5-Level Diode Clamped Multilevel Inverter Using Different PWM Techniques," vol. 2, no. 10, pp. 4121-4129, 2013.
- [3] H. A. Hamed, F. N. Al Mansoori, and E. H. E. Bayoumi, "An effective IGBT driver circuit for three level neutral point clamped converters," *International Journal of Industrial Electronics and Drives*, vol. 4, no. 1, pp. 25-32, 2018.
- [4] V. Fernão Pires, A. Cordeiro, D. Foito, and J. Fernando Silva, "Three-phase multilevel inverter for grid-connected distributed photovoltaic systems based in three three-phase two-level inverters," *Solar Energy*, vol. 174, pp. 1026-1034, 2018.
- [5] S. Srikanth, "A Three Phase Multi Level Converter For grid Connected PV System," *International Journal of Power Electronics and Drive Systems (IJPEDS)*, vol. 5, 2014.
- [6] U.-M. Choi and J.-S. Lee, "Comparative Evaluation of Lifetime of Three-Level Inverters in Grid-Connected Photovoltaic Systems," *Energies*, vol. 13, no. 5, 2020.
- [7] A. Choudhury, "Three-Level Neutral Point Clamped (NPC) Traction Inverter Drive For Electric Vehicles," *Concordia University, Montreal, Canada*, 2015.