

CUK Converter Based P Module For Excitation Of Synchronous Machine

Vishant G. Naik¹ , Santosh Singh Negi²

¹ Student, Dept of EEE , RKDF Institute of Science and Technology, Madhyapradesh , India

² Asst.Professor, Dept of EEE, RKDF Institute of Science and Technology, Madhyapradesh , India

Abstract - *The unavailability of fossil fuel and increasing demand for energy has pushed us towards finding alternative source of energy. The solar energy can be used for excitation of synchronous machine as an alternative source of energy. Due to increasing efficiencies and decreasing cost of PV cells, various MPPT algorithms have been implemented. In this paper a Cuk converter has been used in order to achieve constant excitation voltage which is required for exciting field winding of synchronous machine. MATLAB software has been used for simulation of both solar cell and Cuk converter which are modeled using sim power system blocks.*

KeyWords: Excitation, synchronous machine, photovoltaic (PV), DC to DC Cuk converter.

1. INTRODUCTION

The world demand for electric energy is constantly increasing and conventional energy resources are diminishing and are even threatened to be depleted. The recent change in the environmental conditions such as global warming and rapid increase the demand for electricity led to a need for a new source of energy that is cheaper and sustainable with less carbon emissions.

For these reasons, the need for alternative energy sources has become indispensable, and solar energy in particular has proved to be a very promising alternative because of its availability and pollution-free nature. The unavailability of fossil fuel and increasing demand for energy has pushed us towards finding alternative sources of energy. The solar energy can be converted into electrical energy with the help of solar panel that are made up of silicon photovoltaic cells [1][2].

The organization of the paper is as follows: Section II presents the block diagram of Cuk converter based PV module for excitation of synchronous machine. Section III presents dynamic model of a PV cell [3]. In section IV, the DC-DC boost converter [4][5] is applied for boosting the PV cell output to get the desired voltage which is required for excitation of synchronous machine. In section V, contains excitation methodology and experimental setup

for finding excitation voltage. Section VI presents PV cell waveforms, Cuk converter pulses and generator output waveforms. Finally section VII provides the conclusion.

2. COMPLETE BLOCK DIAGRAM

Figure 1 presents the proposed block diagram structure of the boost converter based solar energy system for an excitation of synchronous machine, where it can be noticed the use of PV cell for excitation of synchronous machine and for desired dc input to synchronous machine Cuk converter has been used.

In large synchronous machines, the field winding is always provided on the rotor, because of certain advantages like more economical, more efficient, better insulation, efficient cooling, more output, lesser rotor weight and inertia, rigid and convenient construction, the present article is given a brief account of the excitation method with the help of Cuk converter based PV energy system as shown in fig.1.

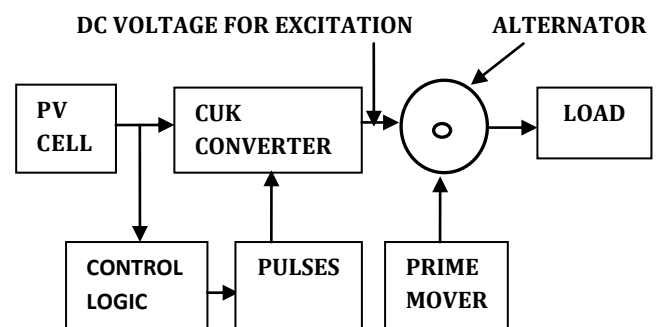

Fig-1: Block diagram of Cuk converter based PV energy system

3. PV CELL MODEL

The building block of PV arrays is the solar cell, which is basically a p-n junction that directly converts light energy into electricity. It has an equivalent circuit as shown below in Figure 2.

The current source I_{ph} represents the cell photo current; R_j is used to represent the non-linear impedance of the p-n Junction; R_{sh} and R_s are used to represent the intrinsic shunt and series resistance of the cell respectively.

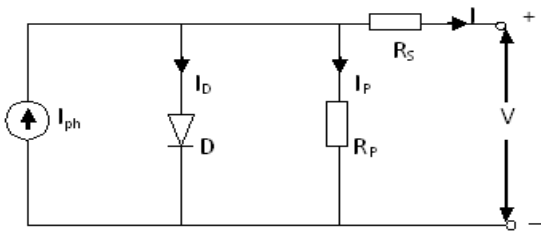

Fig-2: Equivalent circuit of a PV cell

Usually the value of R_{sh} is very large and that of R_s is very small, hence they may be neglected to simplify the analysis. PV cells are grouped in larger units called PV modules which are further interconnected in series-parallel configuration to form PV arrays or PV generators [3].

The PV mathematical model used to simplify our PV array is represented by the equation:

$$I = n_p I_{ph} - n_p I_{rs} \left[e^{\left(\frac{qV}{kT n_s A} \right)} - 1 \right] \tag{1}$$

The cell reverse saturation current I_{rs} varies with temperature according to the following equation:

$$I_{rs} = I_{rr} - \left[\frac{T}{T_r} \right]^3 e^{\left(\frac{qE_g}{kA} \left[\frac{1}{T_r} - \frac{1}{T} \right] \right)} \tag{2}$$

Where T_r is the cell reference temperature, I_{rr} is the cell reverse saturation temperature at T_r and E_g is the band gap of the semiconductor used in the cell.

The temperature dependence of the energy gap of the semi conductor is given by

$$E_g = E_g(0) - \frac{\alpha T^2}{T + \beta} \tag{3}$$

The photo current I_{ph} depends on the solar radiation and cell temperature as follows:

$$I_{ph} = [I_{sc} + k_i(T - T_r)] \frac{S}{100} \tag{4}$$

Where, I_{sc} is the cell short-circuits current at reference temperature and radiation, K_i is the short circuit current temperature coefficient, and S is the solar radiation in mW/cm^2 . The PV power can be calculated using equation (1) as follows:

$$P = IV = n_p I_{ph} V \left[\left(\frac{qV}{kT n_s A} \right) - 1 \right] \tag{5}$$

4. CUK CONVERTER

A very large number of converters have been proposed, which however can be seen to be minor variations of a group of basic DC-DC converters – built on a set of rules. Many consider the basic group to consist of the three types: BUCK, BOOST and BUCK-BOOST converters. The CUK, essentially a BOOST-BUCK converter.

The Buck converter may be seen as a Voltage to Current converter, the Boost as a Current to Voltage converter, the Buck-Boost as a Voltage-Current-Voltage and the CUK as a Current-Voltage-Current converter. All other switching converter must fall into one of these configurations if it does not increase the switching stages further for example into a V-I-V-I converter which is difficult to realize through single controlled switch.

Cuk converter is actually the cascade combination of a boost and a buck converter as shown in fig.3.

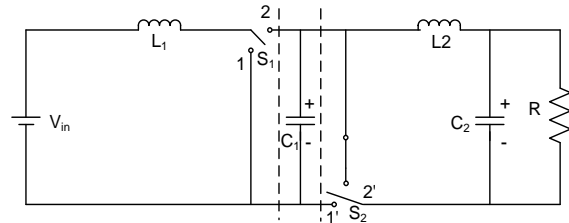
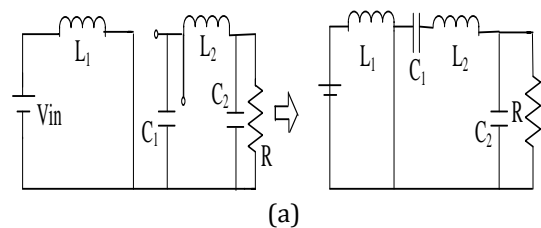

Fig-3: Circuit schematic of a boost-buck converter

S_1 and S_2 operate synchronously with same duty ratio. Therefore there are only two switching states.

- (i) $0 < t \leq DT$
 S_1 to (1) &
 S_2 to (1)

The circuit configuration is given below



- (ii) $DT < t < T$; S_1 to (2) & S_2 to (2')

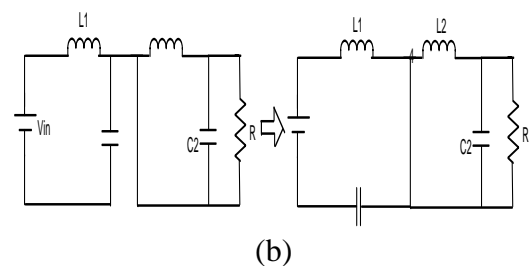

Fig-4: Circuit topology of a boost-buck converter during different switching interval (a) $0 < t \leq DT$ & (b) $DT < t \leq T$

Equivalent circuit of a Cuk converter during different conduction mode: (a) $0 < t \leq DT$ & (b) $DT < t \leq T$ as shown in fig.6

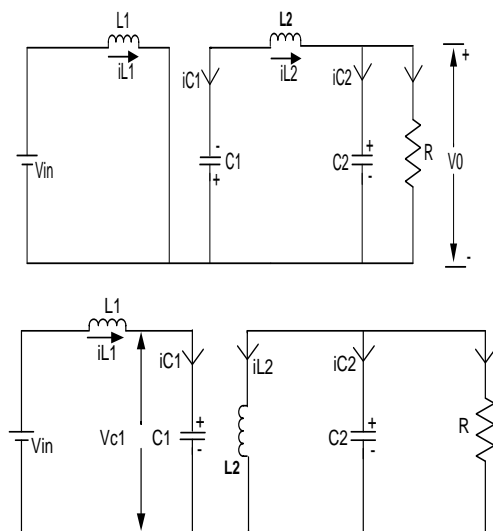

Fig-5: Equivalent circuit of Cuk converter during different conduction modes (a) $0 < t \leq DT$ & (b) $DT < t \leq T$

Expression for average output voltage is given below:

$$V_o = -DV_{c1} = -\frac{DV_{in}}{1-D}$$

5. SYNCHRONOUS EXCITATION

One of the most important elements of electrical power system is a synchronous machine like synchronous generator and synchronous motor. In synchronous generator, mechanical energy (usually from a turbine) is transformed into electrical energy and in synchronous motor electrical energy is transformed into mechanical energy.

Energy transformation is possible only if excitation is exist in synchronous machine. Excitation system usually consists of exciter, Automatic voltage regulator (AVR), power system stabilizer, measuring elements and limitation and protection unit. As here is an implementation of Boost converter based PV cell system for excitation , there is requirement of value of field current i.e, excitation current by performing various test on synchronous machines like Direct, Indirect load test on alternator and V and inverted V curve on synchronous motor on no-load.

From below experimental set up for direct load test on synchronous generator (Rating-2KVA, 400V, 3amp; excitation voltage-220max, excitation amp-0.6), it has been analyses that 0.2 -0.7amp excitation current required for desired induced emf.

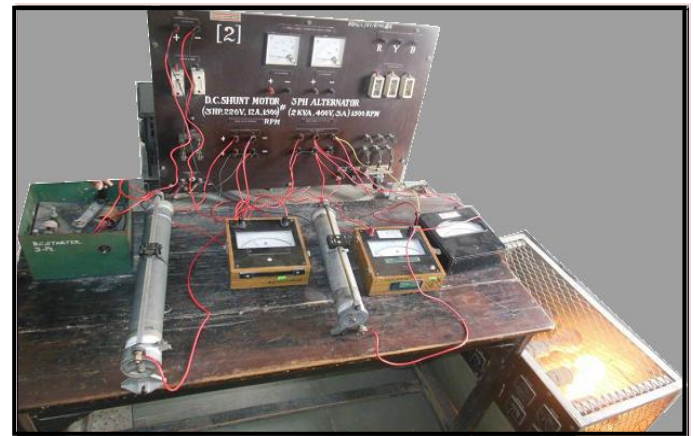

Fig-6 : Experimental set up for Direct Loading

6. SIMULATION RESULT

The above mentioned method has been implemented in MATLAB software and the results are shown below:

The irradiation level changes during the day time i.e. at morning and evening the irradiation level is less compared to afternoon. Therefore, the excitation obtained from PV panel varies with time. So, Cuk converter is used for maintaining constant excitation Fig.7 shows the pulses obtained by implementing MPPT algorithm which is provided to the Cuk converter.

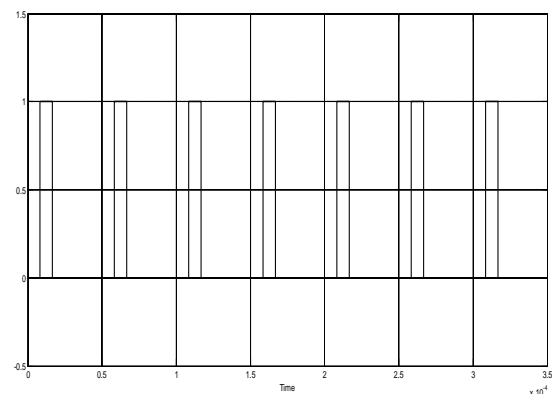

Fig. 7: Cuk converter Pulses

Fig.8 shows the output voltage waveform having magnitude 200V. Since, the field resistance of synchronous machine is 127.77 ohms. The field current flowing through the field winding is 1.575 amps which is shown in fig.9

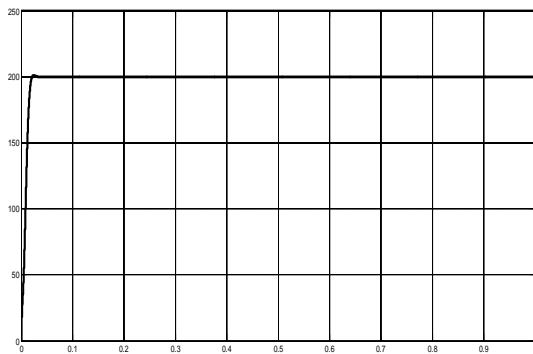

Fig. 8: Solar Voltage Waveform.

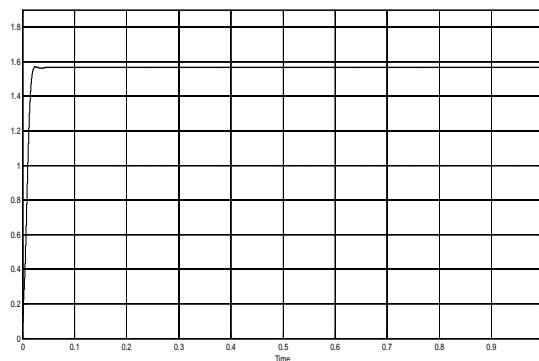

Fig. 9: Field Current

This field current is used to excite the field winding of synchronous machine and the machine is driven at synchronous speed of 1500 rpm shown in fig.10

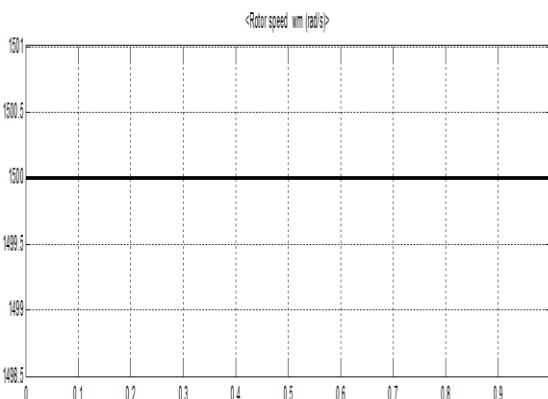

Fig. 10: Speed at which alternator is driven

The emf generated in synchronous machine is given to the load, the output voltage and output current waveform is shown in fig.11

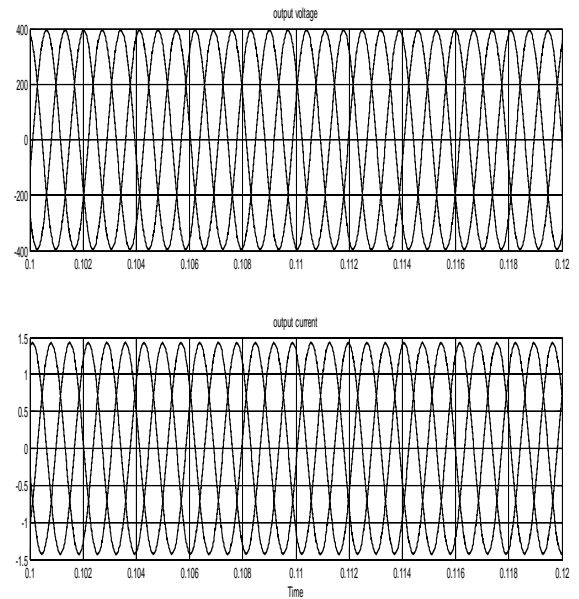

Fig. 11: Output Voltage & Output Current

7.CONCLUSION

This paper implies an alternative method for excitation system of synchronous machine. PV panel has been designed and the output voltage is used as an excitation system for synchronous machine. Since, the irradiation level varies with time, the panel is provided with Cuk converter which ensures the constant excitation for synchronous machine. The constant excitation is achieved by varying the duty ratio of Cuk converter. The output waveforms validate the successful operation..

REFERENCES

- [1] M. G. Villalva, J. R. Gazoli, E. Ruppert F, "Comprehensive approach to modeling and simulation of photovoltaic arrays", IEEE Transactions on Power Electronics, 2009 vol. 25, no. 5, pp. 1198--1208, ISSN 0885-8993.
- [2] Mahrous E. Ahmed, Mostafa Mousa, Mohamed Orabi, "Development of High Gain and Efficiency Photovoltaic System Using Multilevel Boost Converter Topology", 2nd IEEE Symposium for Distributed Generation Systems, 2010.
- [3] M. G. Villalva, J. R. Gazoli, E. Ruppert F, "Modeling and circuit-based simulation of photovoltaic arrays", Brazilian Journal of Power Electronics, 2009 vol. 14, no. 1, pp. 35--45, ISSN 1414-8862.
- [4] W. Xiao, W. G. Dunford, and A. Capel, "A novel modeling method for photovoltaic cells", in Proc. IEEE 35th Annu. Power Electron. Spec. Conf. (PESC), 2004, vol. 3, pp. 1950-1956.

- [5] Santiago J. Amodeo, Hector Gerardo Chiacchiarini, and Alejandro R. Oliva, "High performance control of a DC-DC Z-Source converter used for an excitation field driver," in Proc IEEE , VOL 27, No.6, pp.2947-2957, JUNE 2012.
- [6] Reza Sabzehgar and Mehrdad Moallem, "A boost type power converter for energy regenerative damping" in IEEE trans on mechatronics, VOL.18, NO.2, APRIL, 2013, pp.725-731.
- [7] Farzam Nejabatkhah, Saeed Danyali, Seyed Hosseini, Mehran Sabahi, and Seyedabdolkhalegh Mozaffari Niapour, "Modeling and control of a new three-input DC-DC boost converter for hybrid PV/FC/Battery power system", IEEE, VOL. 27, NO. 5, MAY 2012, pp. 2309-2324.
- [8] F. Z. Peng , H. Li, G. J. Su, and J. S. Lawler, "A new ZVS bidirectional dc-dc converter for fuel cell and battery application," IEEE Trans. Power Electronics, vol. 19, no. 1, pp. 54-65, Jan. 2004.
- [9] Md. Rabiul Islam, Youguang Guo, Jian Guo Zhu, M.G Rabbani, "Simulation of PV Array Characteristics and Fabrication of Microcontroller Based MPPT", Faculty of Engineering and Information technology, University of Technology Sydney, Australia, 6th International Conference on Electrical and Computer Engineering ICECE 2010, 18-20 December 2010, Dhaka, Bangladesh.
- [10] D. S. L. Simonetti, J. Sebasti'an, and J. Uceda, "The Discontinuous Conduction Mode Sepic and Cuk Power Factor Preregulators: Analysis and Design" IEEE Trans. On Industrial Electronics, vol. 44, no. 5, 1997
- [11] N. Mohan, T. Undeland, and W Robbins, "Power Electronics: Converters, Applications, and Design," John Wiley & Sons, Inc., 2003.

BIOGRAPHIES



Pursuing M.Tech from RKDF institute of science and Technology , bhopal , M.P. , India



Asst. Professor in RKDF institute of science and Technology, bhopal , M.P. , India