

Load Frequency Control of a Renewable Source Integrated Four Area Power System using Hybrid Controller

Seema Berwal¹, Balvinder Singh²

¹M.Tech Student, Govt. Women Engineering College Ajmer

²Assistant Professor, Govt. Women Engineering College Ajmer

Abstract – This manuscript deals with the implementation of the adaptive neuro-fuzzy inference system (ANFIS) approach to automatic load frequency control (ALFC) of multi-area multi-source interconnected power systems. ANFIS controller has the advantage of both fuzzy and neural network and stands for the adaptive neuro-fuzzy inference system. The system consists of four equal areas having two thermal reheat plants, a hydro plant with the hydraulic governor and a wind plant with a pitch actuator in each area. The hybrid model of the interconnected power system is developed with ANFIS-PID controller. The simulation work was carried out and the performance evaluation is checked by the proposed control approaches with a 1% step load perturbation in each area. An HVDC link is also introduced with each area to enhance the performance of the power system. Simulation results shows proves the significance of ANFIS-PID controller.

Key Words: Load frequency control, ANFIS-PID controller, Tie line Power deviation.

1.INTRODUCTION

A modern power system is complex and sophisticated with multi area and diverse source of power generation. The control of electric energy with nominal system frequency and tie line power interchange within prescribed limits are very much important. The load frequency control play important role in power pool by maintaining scheduled system frequency and scheduled tie line power in normal operation and during small perturbation.

In a four-area system if any change of power occur in one area, is met by the increase in generating power in other three areas that are interconnected with that system. A multi area system consists of two or more single area systems, connected through a power called tie line. Among all the four areas, each control area can be represented by an equivalent generator, turbine and governor system. The area control error as the controlled output of LFC is driven to zero in order to make the frequency and the tie line power deviations of control areas to zeros [1]. The environmental drive to promote green energy invites new renewable sources of power generation and their corresponding participation factor are more important for the study of LFC.

There is an evolution of intelligent techniques in recent years. Almost all new algorithms report better results than the previous ones in different engineering fields. Some

algorithms give a better solution for some particular problems than others do. The intelligent controllers such as

Particle Swarm Optimization based PID controller [1], Differential Evolution Algorithm based PID controller [2], Differential Evolution Particle Swarm Optimization based PID controller [3], Firefly optimized PID [4], Teaching Learning Based Optimization (TLBO) optimized PID [5].

The growth in size and complexity of electric power system due to nonlinear load characteristics and variable operating points has necessitated the use of fuzzy based methods to address satisfactorily the performance under small perturbations. A jaya algorithm optimized fuzzy pi controller [6], Adaptive Neuro Fuzzy Interface System controller containing SMES-TCPS [7], a Firefly algorithm (FA) optimized fuzzy PID controller [8], Fuzzy gain scheduled PI controller [9].

It has been observed in literature survey that most of the researchers adopt thermal-thermal or thermal hydro systems in LFC studies. The bulk power transmission through HVDC lines connected with AC lines possesses many advantages like fast controllability of HVDC lines through convertor control, ability to reduce the transient stability problem of AC lines and other economical and technical operation of power system.

The authors have proposed a ANFIS-PID controller for load frequency control of the present scenario of a realistic power system with four areas having multi sources of power generation including renewable generation source. Moreover, the proposed ANFIS-PID controller is easily implemented. The main investigations of the present work:

The main investigations of the present work

- To propose an ANFIS PID controller for the load frequency control of a realistic power system.
- To compare the dynamic performances of the ANFIS-PID controller with PID controller for a multi-area multi-source power system with an HVDC link between control areas having a 1% step load perturbation in each area.

This paper is organised in five sections; the 1st section is the introduction part which is explained above. In section 2nd system investigation is done. Section 3rd describes control methodology for stabilization of frequency power systems.

Section 4th is devoted to the simulation models and simulation results. Conclusion is derived in section 5th.

2. SYSTEM DISCRIPTION

In real practice the system of a single generator that feeds a large and complex area has rarely occurred. Several generators connected in parallel may be at a single location or at a different location to meet the load demand of such a large area. Large load areas are divided into several small areas and load demand is met accordingly by interconnected power systems. The aim of the control system now is to regulate the tie line power of the system at same instants as per intra area power contracts.

The two identical area power system interconnected by parallel AC-DC tie lines [10-13] which comprises more practical combination of generating units such as reheat thermal, hydro and gas units in each area. In the present study four equal areas of power system, one area having thermal, hydro and wind power plants participating in LFC is simulated by the proposed FPID controller using MATLAB Simulink. A dc link is also connected in the power system to improve the dynamic response of the system. For, the sake of simplicity only one area is shown in simulink model. Furthermore, the generators in each area may or may not participate in the LFC task and the participation rates are not same for all participating generators. The summation of participation factor of all participating generators is equal to unity in each control area. The nominal parameters of the power system are given in Appendix.

3. CONTROL METHODOLOGY

3.1 PID Controller

PID controller is a closed loop feedback mechanism widely used in industrial control systems. The PID controller involves three separate parameters, namely proportional, integral and derivative gain values. The proportional parameter action determines the reaction based on the current error the integral action determines the reaction based on the sum of recent errors and derivative action determines the reaction based on the rate at which the error has been changing, and the weighted sum of these three actions is used to adjust the process via the final control element.

The transfer Function of a PID controller has the following form:

$$G_c(s) = K_p + \frac{K_i}{s} + K_d s$$

Where K_p , K_i , and K_d are the proportional, integral, and derivative gains, respectively.

The objective of any controller of load frequency is to produce a controlling signal which keeps the frequency of given system constant and power exchange between control areas at predetermined values. The area control error (ACE)

is input to the PID controller. [14] The ACE signal includes the data about frequency error and tie line power error for the related control area. In this control, ACE_1 , ACE_2 , ACE_3 and ACE_4 are made linear combination of frequency and tie line power error[15]. They may be represented for areas,

$$ACE_1 = \Delta P_{12} + B_1 \Delta F_1$$

$$ACE_2 = \Delta P_{23} + B_2 \Delta F_2$$

$$ACE_3 = \Delta P_{34} + B_3 \Delta F_3$$

$$ACE_4 = \Delta P_{41} + B_4 \Delta F_4$$

3.2 ANFIS-PID Controller

This section explains the fundamental concepts of the ANFIS model. ANFIS architecture uses the two intelligent techniques viz. artificial neural network (ANN) and fuzzy logic. Normally ANFIS is considered as an adaptive network and is closely related to ANN. The essential part of neuro fuzzy modelling comes from a common framework called adaptive network which unifies the neural network and the fuzzy model. ANFIS is functionally equivalent to a fuzzy inference system (FIS) because it is an adaptive network and its operations are performed under any one of the adaptive network simulators. An easy rule base model is used for explaining the basic idea of ANFIS architecture. Consider the FIS having Takagi and Sugeno's controller with x and y as two inputs and z as an output [7]. For the first order of Sugeno fuzzy model, distinctive rule sets are expressed as:

If x is A1 and Y is B1 then $f_1 = p_1x + q_1y + r_1$

If x is A2 and Y is B2 then $f_2 = p_2x + q_2y + r_2$

Where p, q, and r are linear output parameters. The formation of this architecture involved the use of five layers and two if-then rules.

For designing the ANFIS controller, the neural network backpropagation method is used for training FIS parameters[7]. Before tuning the parameters, the neural network treats the components in a fuzzy system as a parametric form. In this way, the fuzzy systems are converted to a neuro-fuzzy system.

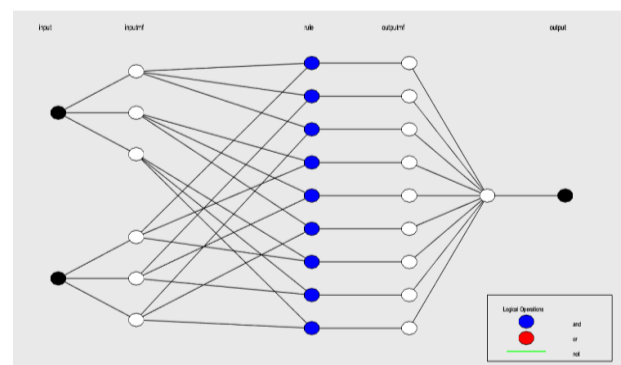

Fig 1 ANFIS architecture

ACE signal and its derivative with respect to time ($d(ACE)/dt$) are treated as the input signals to the ANFIS controller. Depending on these two input signals, the fuzzy membership functions produce the output stabilizing signal. This proposed approach of ANFIS controller design is used for modeling and simulation of frequency damping as well as tie-line power deviation in the power system.

Step 1: Model and simulate the test system with Simulink and fuzzy logic controller with the given rule base.

Step 2: Collect the training data while simulating the model with a fuzzy logic controller.

Step 3: The two inputs, i.e. ACE and $d(ACE)/dt$, and the output signal provide training data.

Step 4: Use anfisedit to generate the ANFIS .fis file.

Step 5: Arrange the training data collected in step 2 and generate the FIS with gbell membership function.

Step 6: Trains the collected data with the generated FIS up to a particular no. of Epochs.

Step 7: Save the FIS. This FIS file is the Neuro-Fuzzy enhanced ANFIS file.

4. SIMULATION MODEL AND RESULTS

4.1 Simulation Model

Simulink model of the power system to check the simulation result for both PID and ANFIS-PID controller is developed with MATLAB/SIMULINK. This design is implemented in MATLAB/SIMULINK to examine the performance of ANFIS-PID controller.

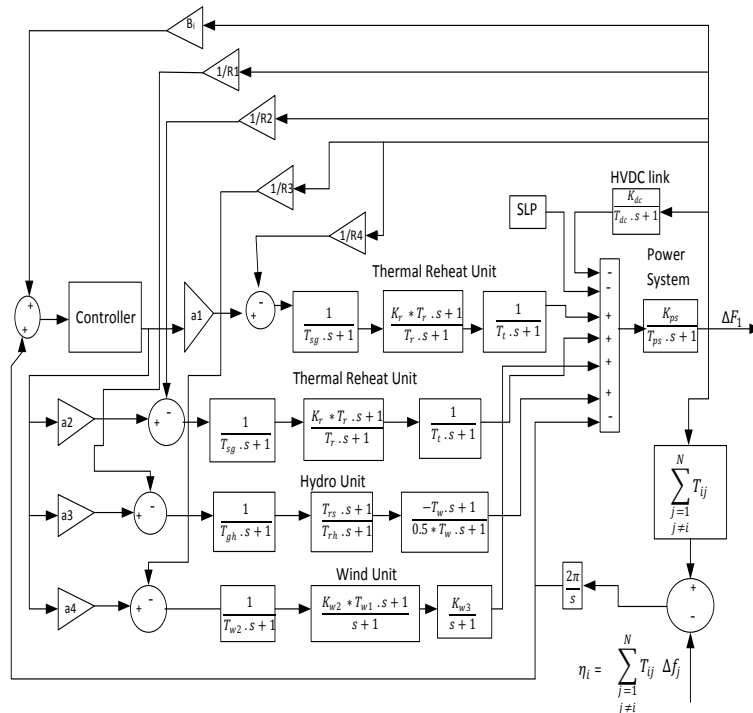

Fig 2 Simulink model of Four area multi source

4.2 Simulation Results

The model of the system under study has been developed in MATLAB/Simulink environment. The following simulations were performed on all areas with conventional PID and FPID controller with 1% SLP in all areas.

A) Frequency Response

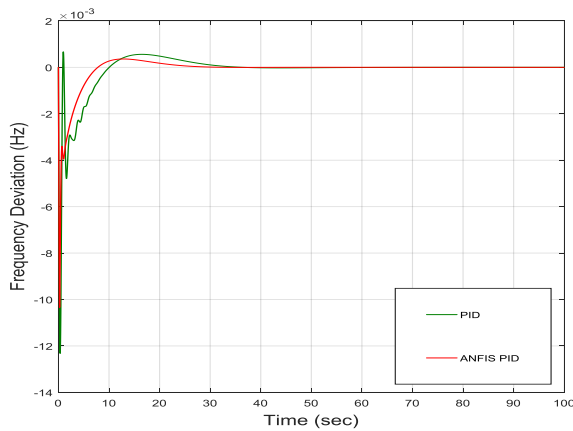

Fig. 3 Frequency deviation of area 1

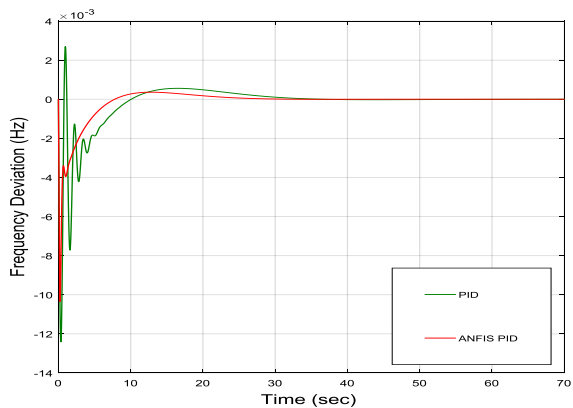

Fig. 4 Frequency deviation of Area 2

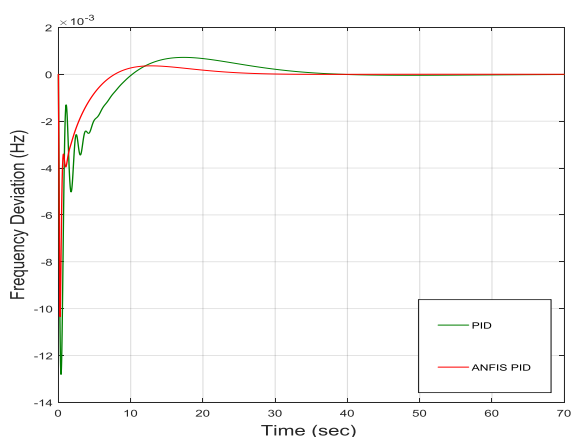

Fig. 5 Frequency Deviation of Area 3

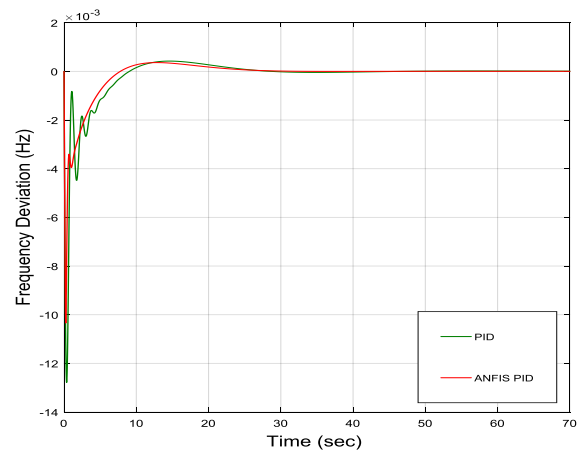

Fig. 6 Frequency Deviation of Area 4

B) Tie Line Power Deviation

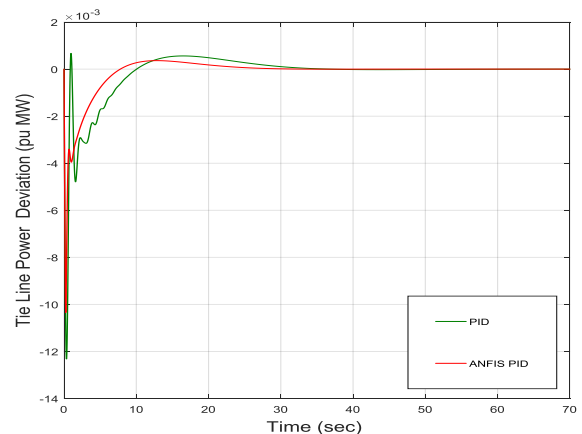

Fig. 7 Tie Line Power Deviation of Area 4-1

C) Comparison Tables

Table 4.1 Settling Time (sec)

| Controller | ΔF of Area 1 | ΔF of Area 2 | ΔF of Area 3 | ΔF of Area 4 | ΔF of Area 5 |
|------------|----------------------|----------------------|----------------------|----------------------|----------------------|
| PID | 35 | 35 | 35 | 35 | 35 |
| ANFIS-PID | 31 | 30 | 30 | 30 | 31 |

Table 4.2 Peak Undershoot (pu)

| Controller | ΔF of Area 1 | ΔF of Area 2 | ΔF of Area 3 | ΔF of Area 4 | ΔF of Area 5 |
|------------|----------------------|----------------------|----------------------|----------------------|----------------------|
| PID | -0.0124 | -0.0124 | -0.0128 | -0.0128 | -0.0122 |
| ANFIS-PID | -0.0103 | -0.0103 | -0.0103 | -0.0103 | -0.0103 |

5. CONCLUSION

Load frequency control becomes more important, when a large amount of renewable power supplies like wind power generation are introduced. In this paper, load frequency control with considerable penetration of renewable has been analysed in the presence of Thermal, Hydro and Wind

Systems with ANFIS-PID controller. It is observed that frequency deviation is low when wind system is introduced in actual power system, and it is within the tolerable limits for fixed load variations. When ANFIS-PID controller is compared to PID controller gives steady state error zero in less time than the other one.

APPENDIX

| Parameters | Description | Value | Unit |
|---|--|------------|--------------|
| B ₁ , B ₂ , B ₃ , B ₄ | Tie line frequency bias in areas 1,2,3 &4 | 0.425 | pu MW/Hz |
| R ₁ , R ₂ , R ₃ , R ₄ | Regulations of governors in areas 1, 2,3 &4. | 2.4 | Hz/pu MW |
| T _{sg} | Speed governor time constant | 0.08 | sec |
| T _t | Steam turbine time constant | 0.3 | sec |
| T _r | Steam turbine reheat time constant | 10.2 | sec |
| K _r | Steam turbine reheat constant | 0.3 | Thermal unit |
| T _w | Nominal starting time of water in penstock | 1.1 | sec |
| T _{rs} | Hydro turbine speed governor reset time | 5 | sec |
| T _{rh} | Hydro turbine speed governor transient droop time constant | 28.75 | sec |
| T _{gh} | Hydro turbine speed governor main servo time constant | 0.2 | sec |
| T _{w1} , T _{w2} | Time constant of hydraulic pitch actuator of wind turbine | 0.6, 0.041 | sec |
| K _{w2} | Hydraulic pitch actuator constant | 1.25 | - |
| K _{w3} | Pitch constant of wind | 1.3 | - |

| | | | |
|-----------------|------------------------------|------|-----|
| | turbine | | |
| K _{dc} | Gain of HVDC system | 1 | - |
| T _{dc} | Time constant of HVDC system | 0.2 | sec |
| ΔF | Change in frequency | - | Hz |
| ΔP _D | Change in load | 0.01 | pu |

REFERENCES

- [1] Jitsaran Seekuka, Rapeepong Rattanawaorahirunkul, Siriporn Sansri, Sawinee Sangsuriyan, Aran Prakonsant "AGC Using Particle Swarm Optimization based PID Controller Design for Two Area Power System" IEEE 2016, pp. 1-4.
- [2] S. Kumari, G. Shankar, S. Gupta, K. Kumari "Study of Load Frequency Control by using Differential Evolution Algorithm" 1st IEEE International Conference on Power Electronics, Intelligent Control and Energy Systems (ICPEICES), 2016, pp. 1-5.
- [3] Nimai Charan Patel, Manoj Kumar Debnath, Durgesh Prasad Bagarty, Pranati Das "Load Frequency Control of a Non-Linear Power System with Optimal PID Controller with Derivative Filter" IEEE International Conference on Power, Control, Signals and Instrumentation Engineering (ICPSCI), 2017, pp. 1515-1520.
- [4] Manmadha Kumar Boddepalli, Prema Kumar Navuri "Design and Analysis of Firefly Algorithm based PID Controller for Automatic Load Frequency Control Problem" IEEE International Conference on Technologies for Smart-City Energy Security and Power (ICSESP), March 28-30, 2018, Bhubaneswar, India, pp. 1-5.
- [5] Jyoti Ranjan Nayak, Tridipta Kumar Pati, Binod Kumar Sahu, Sanjeeb Kumar Kar "Fuzzy-PID Controller Optimized TLBO Algorithm on Automatic Generation Control of a two-area Interconnected Power System" International Conference on Circuit, Power and Computing Technologies [ICCPCT], 2015, pp. 1-4.
- [6] Priyambada Satyapathy, Manoj Kumar Debnath, Manjit Bahadur Singh, Pradeep Kumar Mohanty "Design of FPI controller for Load Frequency Control of a Nonlinear Power System", IEEE International Conference on Technologies for Smart City Energy Security and Power (ICSESP), 2018, pp. 1-6.
- [7] Abhijith Pappachen, A. Peer Fathima "Load Frequency Control in Deregulated Power System Integrated with SMES-TCPS Combination using ANFIS Controller", Electrical Power and Energy Systems 82(2016), pp. 519-534
- [8] Pratap Chandra Pradhan, Rabindra Kumar Sahu, Sidhartha Panda "Firefly algorithm Optimized Fuzzy PID Controller for AGC of Multi-Area Multi-Source Power

Systems with UPFC and SMES” Engineering Science and Technology, an International Journal 19, 2016, pp.338-354.

[9] Sathans, Akhilesh Swarup “Intelligent Load Frequency Control of Two-Area Multi Unit Power System with SMES” 21st International Conference on Systems Engineering, 2011, pp. 147-152.

[10] Ibraheem, N., Nizamuddin, & Bhatti, T. S. “AGC of Two Area Power System Interconnected by AC/DC links with Diverse Sources in Each Area”, International Journal of Electrical Power & Energy Systems, 2014, Vol. 55, pp. 297–304.

[11] Mohanty, B., Panda, S., & Hota, P. K. “Controller Parameters Tuning of Differential Evolution Algorithm and its Application to Load Frequency Control of Multi-Source Power System”, International Journal of Electrical Power & Energy Systems, 2014, Vol.54, pp.77–85.

[12] Parmar, K. P. S., Majhi, S., & Kothari, D. P. “Improvement of Dynamic Performance of LFC of the Two Area Power System: An Analysis using MATLAB”, International Journal of Computer Applications in Technology, 2012a, Vol. 40, pp.28–32.

[13] A. K. Barisal, Somnath Mishra, “Improved PSO based Automatic Generation Control of Multi Source Non Linear Power Systems Interconnected by AC/DC links”, Cogent Engineering (2018), 5:1422228.

[14] Afshan Ilyas, Shagufta Jahan, Mohammad Ayyub, “Tuning Of Conventional PID And Fuzzy Logic Controller Using Different Defuzzification Techniques”, International journal of scientific & technology research, Vol. 2, issue 1, January-2013, pp.138-142

[15] Surya Prakash , S.K. Sinha “Impact of Slider Gain on Load Frequency Control using Fuzzy Logic Controller” ARPN Journal of Engineering and Applied Science, Vol.14,No.7,Sep 2009

[16] Tripathi S C, Juengst K P, “Sampled Data Automatic Generation Control with Superconducting Magnetic Energy Storage in Power System”, IEEE Trans. Energy Converse 12(2) , 1997,pp. 187-92 .

[17] V. Shanmugasundaram, T. Jayabarathi, “A fuzzy Approach of Autonomous Power Generating Systems” ,Procedia engineering 38(2012), pp. 753-762.