

# BIOMETRIC BASED ATTENDANCE SYSTEM AND STUDENTS MONITORING SYSTEM BASED ON QR CODE

V. Venkata Subbu<sup>1</sup>

<sup>1</sup>St. Joseph's College of Engineering and Technology, AP/ECE, Thanjavur.

\*\*\*

**ABSTRACT:** In modern years, there have been increase in the quantity of applications based on Radio Frequency Identification (RFID) systems and Quick Response code (QR), have been effectively applied to different areas as miscellaneous as transportation, health-care, agriculture, and hospitality industry to name a few. In our project, an attempt is made to solve persistent attendance monitoring problem in developing countries using RFID technology. The application of RFID to attendance monitoring as developed and deployed in this study is capable of eliminating time wasted during labor-intensive collection of attendance and an opportunity for the educational administrators to capture face-to-face classroom statistics for allocation of appropriate attendance scores and for further managerial decisions. RFID is rapidly evolving, and is used with Biometrics technology for security purpose. For security purpose our project is based on another field also i.e., Biometric Access Control System. It provides the highest level of security available today by eliminating the stolen, transferred and duplicating. It also will eliminate the troubles related with blue-collar work associated with paper based and punch card. By using QR code students and parents can access the reports of individuals like exam all plan schedule, profile, attendance percentage, library details etc.

Key words: Attendance, Bio-metric, QR code, Students.

## 1. INTRODUCTION

This paper consists of two sections. First section is By using RFID technology and QR code make a digital revolution in the college campus. Using RFID and Bio-metric system (Finger Print) provide a proxy free attendance and thus reducing the timings of the student and lecturer. The students should punch the RFID card along with Finger Print scanning, if the student fails to scan their Finger Print means the respective student is marked as an absent. Second section is based on an Application which is fully based on QR code. The QR code which is pasted on your ID-Card which is to be scanned by an application. After scanned the application provides details like student's profile, attendance percentage, exam hall plan details, exam schedule, library details.

## 2. METHODS

In this paper there were two models. One is based on RFID and another one is based on QR Code.

### 2.1 RFID

RFID (Radio Frequency Identification) is widely used technology in all field applications. It provides a single identity to any individuals. Used in desired application frequencies. The normally used frequency range is 125-300 KHz. It has a reader and tag components. The tag and reader has available both in an active and passive modes. It provides a secure approach to any individuals, so we use RFID in this project.

## 2.2 RFID COMPONENTS:

### 2.2.1 RFID TAGS:

An **RFID tag** is a microchip combined with an antenna in a compact package; the packaging is structured to allow the RFID tag to be attached to an object to be tracked. "RFID" stands for Radio Frequency Identification. The basic premise behind RFID systems is that you mark items with tags. These tags contain transponders that emit messages readable by specialized RFID readers. Most RFID tags store some sort of identification number; for example a customer number or product SKU (stock keeping unit) code. A reader retrieves information about the ID number from a database, and acts upon it accordingly. RFID tags can also contain writable memory, which can store information for transfer to various RFID readers in different locations. This information can track the movement of the tagged item, making that information available to each reader. RFID tags fall into two general categories, active and passive, depending on their source of electrical power. Active RFID tags contain their own power source, usually an on-board battery. Passive tags obtain power from the signal of an external reader.

Tags can be also attached to almost anything:

- a) Items, cases or pallets of products, high value goods
- b) vehicles, assets, livestock or personnel

**Passive Tags:**

Passive tags, on the other hand, are cheap; they can cost as little as 20 cents apiece, and new technologies are constantly making them cheaper to integrate into common materials and products. In addition to their low cost, passive tags can also be quite small. Current antenna technology limits the smallest useful passive tag to about the size of a quarter. The larger the tag, the larger the read range. Currently, passive RFID tags contain about 2 Kbits of memory. This is too small to hold much more complex information than identification and history information. The technology behind RFID is constantly improving, so the amount of information and capabilities of RFID tags will increase over time, allowing RFID tags to eventually contain and transmit much more information. A passive-tag reader can constantly broadcast its signal or broadcast it on demand. When a tag comes within the reader's range, it receives an electromagnetic signal from the reader through the tag's antenna. The tag then stores the energy from the signal in an on-board capacitor; a process called *inductive coupling*. When the capacitor has built up enough charge, it can power15 RFID tag's circuitry, which transmits a modulated signal to the reader. That return signal contains the information stored in the tag. Passive tags typically operate at frequencies of 128 KHz, 13.6 MHz, 915 MHz, or 2.45 GHz, and have read ranges of a few inches to 30 feet .Frequency choice depends on the system's environment, what material the signal must travel through, and the system's required read range. RFID tags can be encased in many materials. Plastics are a very common material for RFID, forming identification cards for building access, credit cards, or bus fares.

In short, Passive tags,

- a) Do not require power – Draws from Interrogator Field
- b) Lower storage capacities (few bits to 1 KB)
- c) Shorter read ranges (4 inches to 15 feet)
- d) Usually Write-Once-Read-Many/Read-Only tags
- e) Cost around 25 cents to few dollars

**Active Tags:**

Because they have their own power source, active tags transmit a stronger signal, and readers can access them from further away. The on-board power source makes them larger and more expensive, so active RFID systems typically work best on large items tracked over long distances. Low-power active tags are usually slightly larger than a deck of playing cards .Active tags can remain dormant until they come in range of a receiver or can constantly broadcast signal. Because of their on-board power source, active tags operate at higher frequencies—commonly 455 MHz, 2.45 GHz, or 5.8 GHz—depending on the application's read range and memory requirements Readers can communicate with active RFID tags across 20 to 100 meters.

In short, active tags,

- a) Battery powered
- b) Higher storage capacities (512 KB)
- c) Longer read range (300 feet)
- d) Typically can be re-written by RF Interrogators
- e) Cost around 50 to 250 dollars

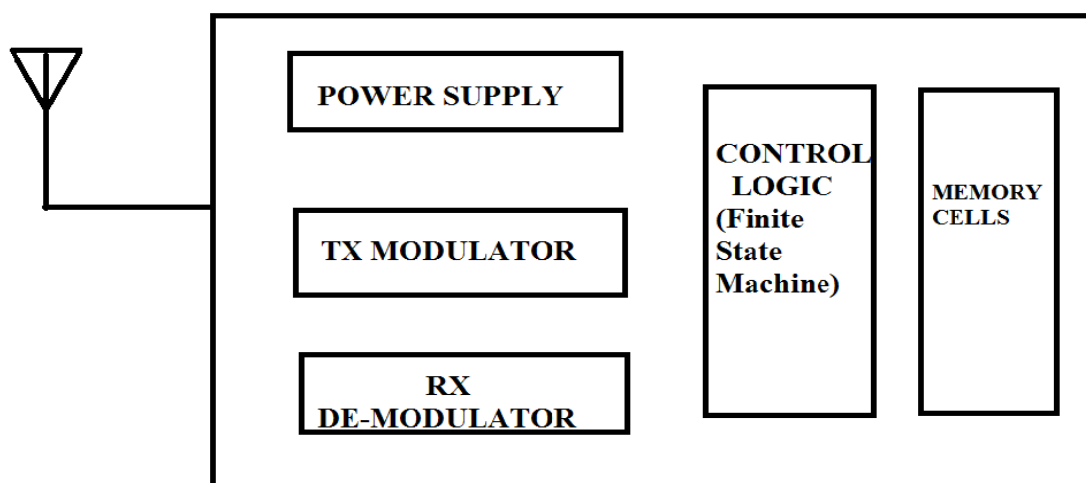

FIG:2.1 TAG BLOCK DIAGRAM

**2.2.2 RFID TAG MEMORY:**

**Read Only Tags:**

Tag ID is assigned at the factory during manufacturing

- Can never be changed
- No additional data can be assigned to the tag

**Write Once, Read Memory(WORM) Tags:**

Data written once, e.g., during packing or manufacturing

- Tag is locked once data is written
- Similar to a compact disc or DVD

**Read or Write:**

- Tag data can be changed over time
- Part or all of the data section can be locked

**2.2.3 RFID READERS:**

The RFID reader continuously transmits a 125 kHz carrier signal using its antenna. The passive RFID tag, embedded in an id card for example, powers on from the carrier signal. Once powered on, the tag transmits, back to the reader, an FSK encoded signal containing the data stored on the card.

The FSK signal is a 125 kHz carrier, with 12.5 kHz as the mark frequency, and a 15.625 kHz as the space frequency. The encoded signal is picked up by the reader's antenna, filtered, and processed on the embedded microcontroller to extract the tag's unique identity. At this point the identity can be matched against the records stored in the database.

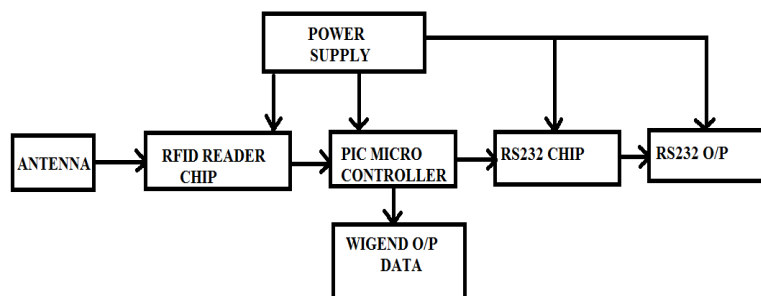

FIG 2.2 : RFID BLOCK DIAGRAM

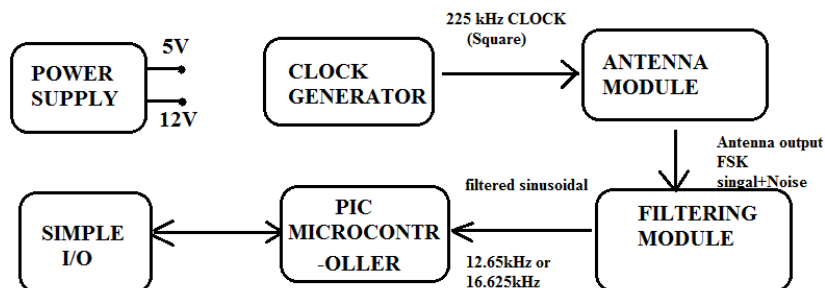

FIG 2.3: INTERNAL BLOCK DIAGRAM OF READER

**QR CODE**

Abbreviated from Quick Response Code. It is a 2D Bar Code. It is made up of black squares and white squares. Each square is called as modules. Data present in QR code is represented in terms of Bytes. Three corners are the heart of QR code. The structure of the QR code is shown below:



FIG 2.4 QR CODE

Three large squares define the position markers. Smaller square is an alignment marker. Alternating black and white modules defines timing patterns. Red section defines format.

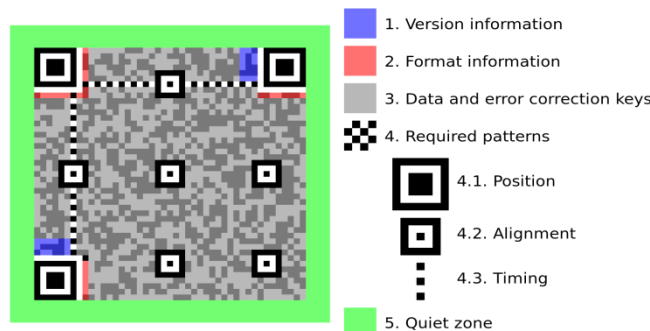

FIG 2.5 QR CODE SPECIFICATION

A module highlighted in blue represents version number. (V40 177\*177 modules). Colored QR code is also available to increase the data density. Bytes may be readable or un-readable.

**WORKING PRINCIPLE**

First section of this paper is based on RFID and FingerPrint based attendance monitoring system.

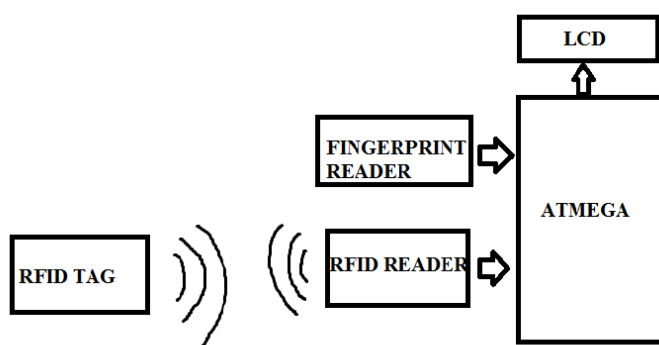

FIG 2.6: HARDWARE UNIT

Students having RFID card as like as ID card for their identity. Once the RFID tag is punched the reader reads the content which is hold by the tag. For second level authentication bio-metric i.e. finger print system is involved. The RFID details along with finger print details should be matched with the students data base management system. If the data were matches, the LCD

displays the reslut as positive manner, otherwise the LCD shows as negative message and the respctive individual is marked as absent. If you fail to record the finger print impression or RFID alone means you should be marked as absent. So you should record the both details at the same time, so only you should be marked as present.

Second section of this paper deals with an application based on QR Code for students benefit. It clearly gives students and management information like Student Profile, Attendance Percentage, Exam hallplan and Schedule.

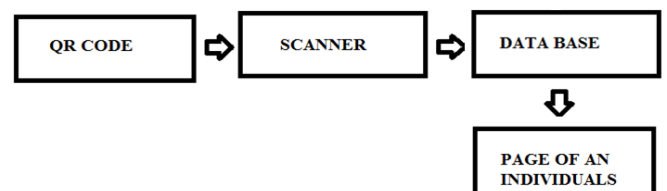

FIG 2.7: QR CODE PROCESSING

The QR code is pasted on your ID card instead of BARCODE. After the QR code is scanned by an application, the respective page of an individuals will be displayed. The displayed page contains many buttons for concern opertaions. The operation is fully based on ADMIN and STUDENT activities.

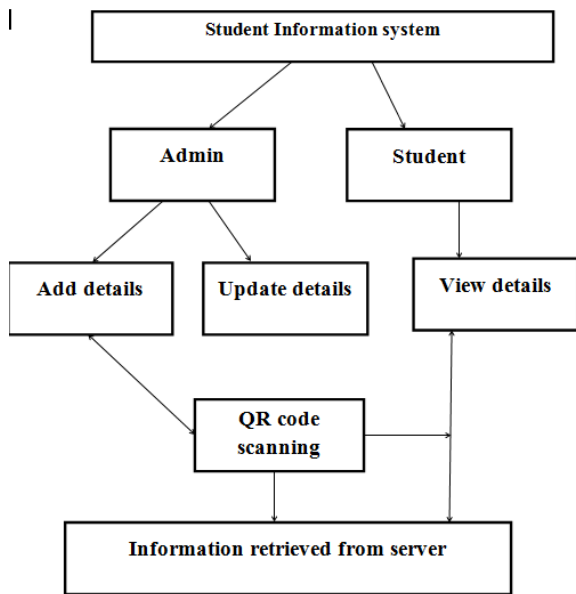

FIGURE 2.8: ARCHITECTURE

The architecture clearly tells about admin and students details. Admin can add details and update the timely informations. Students can view details by scanning QR code, the concern result will be displayed and its retrieved from the server.

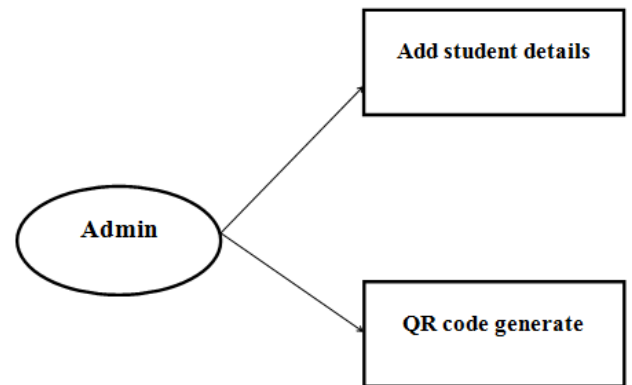

FIG 2.9: LEVEL1

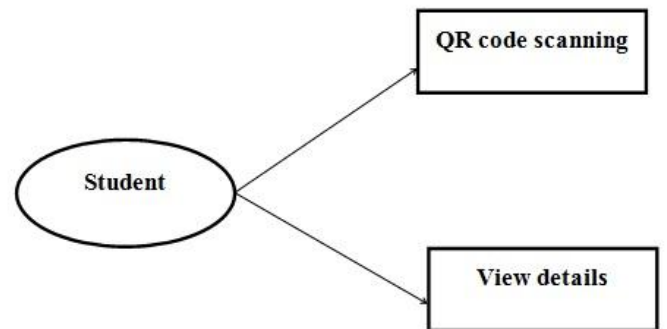

FIG2.10 LEVEL2

The level 0,1,2 describes the detailed information about the admin and student activities.

### 3. RESULTS

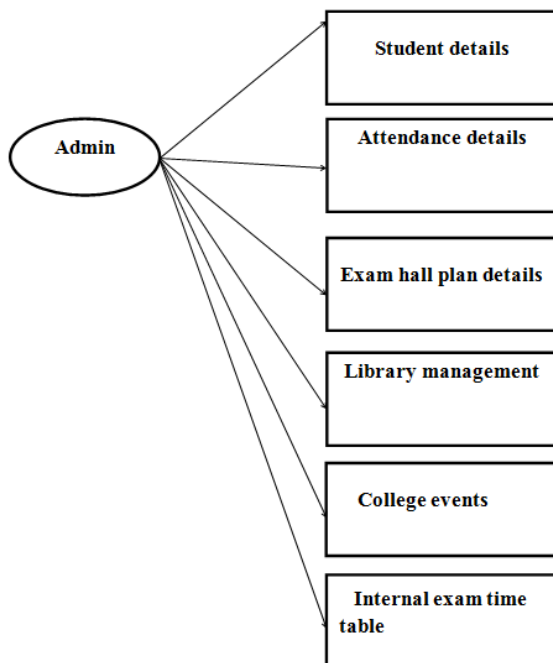
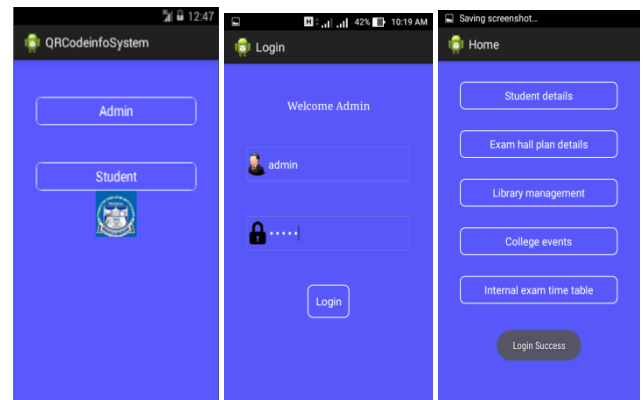

FIG 2.8:LEVEL0

The following images shows about STUDENT process.

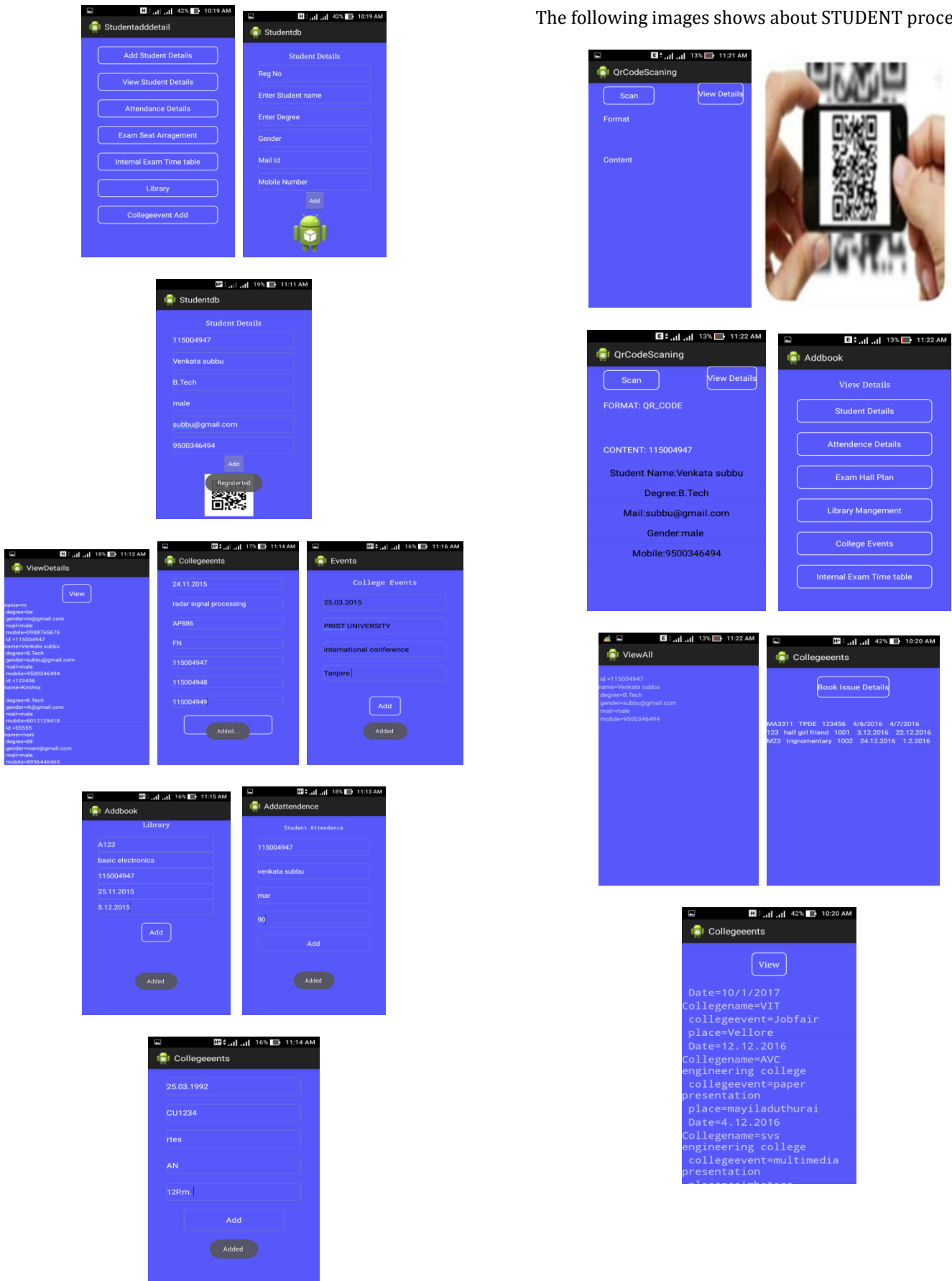

FIG 3.0 ADMIN PROCESS

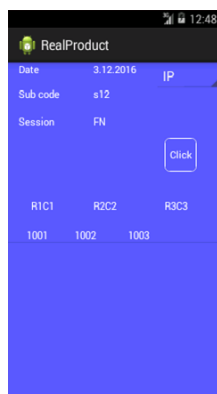
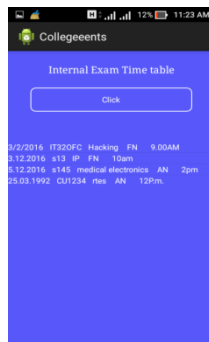
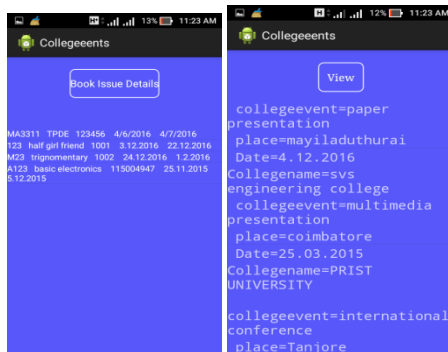
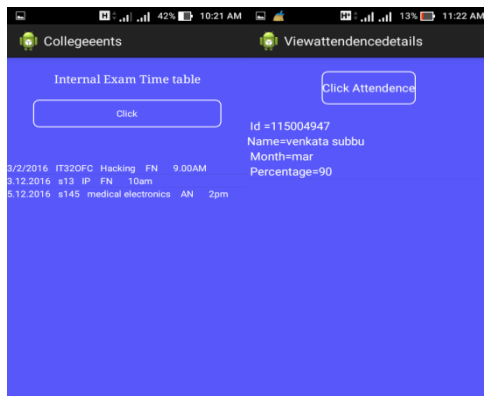

FIG 3.1 STUDENT PROCESS

#### 4. CONCLUSION

As the RFID technology evolves, further refined applications will utilize the prospective of RFID to accept, accumulate and forward data to a remote sink source. In this project, we have utilized the flexibility of RFID in implementing well-designed and automatic

attendance management system and fingerprint identification system.

Attendance management is very helpful in saving valuable time of students and teachers, paper and generating report at required time. QR technology is a well growing technology for reducing the time and easy to know information at anywhere.

#### 5. FUTURE SCOPE

For avoiding misunderstanding between the faculty and parent due to student's attendance details. Students may tell lie about their attendance details, to avoid that, the tracking system should be provide to track the students where they are.

#### 6. REFERENCES

[1] Ali Nur Mohammad Noman, Kevin Curran, and Tom Lunney, Tom Lunney A Watermarking Based Tamper Detection Solution for RFID Tags

[2] Murizah Kassim, Hasbullah Mazlan, Norliza Zaini, Muhammad Khidhir Salleh "Web-based Student Attendance System using RFID Technology"

[3] RFID Based Exam Hall Maintenance System, Parvathy A,Venkata Rohit Raj Gudivada,Venu Madhav Redy M,Manikanda chaitanya SASTRA Unviersity

[4] T.S. Lim, S.C. Sim and M.M. Mansor, 2009 "RFID Based Attendance System", 2009 IEEE Symposium on Industrial Electronics and Applications (ISIEA 2009), Kuala Lumpur, Malaysia

[5] RFID in cloud environment for Attendance monitoring system, A.Parvathy, B. Rajasekhar, C.Nithya, K.Thenmozhi, J.B.B. Rayappan, Pethuru Raj and Rengarajan Amirtharajan,SASTRA University

[6] Y.Liu,M.Y.Liu,"Research on Data Encoding of Two-Dimensional QR Code Barcode",Transactions of Beijing Institute of Technology, Vol.25,NoA,pp.352-355, Apr.2005.

[7] H.zhang,Q.W.Han,F.M.Yu,"Two Dimensional Bar Code in Medicine Trade Logistic Management System",Journal of Chongqing University, Vol.27,NoA,pp.122-125, Apr.2004.

[8] X.X.H uang,"Research on Restaurant Reservation System Based on Two

Dimensional Bar Techology",China Computer & Communication , pp.61-62, Feb.2010.

[9] C.Y.Kang. "Study on System of Electronic Ticket on Two-dimensional

Code", Journal of Harbin University of Commerce (Natural Sciences Edition), Vol.25, No.2, pp.178-181, Apr.2009.

**AUTHORS SHORT PROFILE****AUTHOR DETAILS:****NAME: VENKATA SUBBU.V****DESIGNATION: ASSISTANT PROFESSOR**