

# Design Parameters and Fluid Interaction of Amphibious Structures

Jainandan I<sup>1</sup>, Govind<sup>1</sup>, Chethan R<sup>1</sup>, Jagannath Gopal Rathod<sup>1</sup>, Abhishek M Talageri<sup>2</sup>

<sup>1</sup> Student, Department of Civil Engineering, Dayananda Sagar College of Engineering, Karnataka, India

<sup>2</sup> Asst. Professor, Department of Civil Engineering, Dayananda Sagar College of Engineering, Karnataka, India

\*\*\*

**Abstract** - In recent years, rise in sea level has been one of the predominated effects of global warming caused by humans since the past century. Some of the prime cities in the world are located along coastlines can disappear in the following years to come. An increase in the frequency of floods and storms has led the cities to shut down momentarily. Many flood-resistant techniques have come up such as flood walls, high discharge sewers and IoT devices. Amphibious structures are capable building that is made to withstand floods by rising due to buoyancy in the occurrence of flood and resting in the absence of the same. In this paper, a 3-storey amphibious structure is designed taking inspiration from offshore and ship design principles. The objective of this paper is to provide a brief idea of designing amphibious structures.

**Key Words:** Global warming, flood, Amphibious structure, Float, Buoyancy

## 1. INTRODUCTION

Global warming is an increase in the average earth temperature caused since the start of the industrial period mainly due to the burning of fossil fuels which intern produces greenhouse gases that include carbon dioxide, methane, tropospheric ozone, etc. Sunlight after reaching the earth, the surface absorbs a part of sunlight energy and reradiates as infrared waves. The molecules of greenhouse gases interact with the wavelength of infrared waves and re-emits half of the infrared energy back to earth as heat and the rest to outer space. As a result, greenhouse gases contribute to the intensity of heat waves which can imbalance the hydrological cycle sending more or less precipitation to an area. In an event of a decrease in rainfall results in drought and an increase in rainfall fills more water in the tributaries or water bodies than it can normally handle which results in flood.

Floods are categorized into 3 types, coastal, riverine and shallow flooding. Coastal floods are caused by storms that occur in the sea or oceans, due to high wind and air pressure they are pushed towards the shore and move inland resulting in floods. Riverine floods are caused by excessive rainfall that results in an overflow of a tributary to the adjacent land. Shallow flooding is caused by a lack of drainage due to continuous excessive rainfall and it is typically seen in urban areas.

Floods results in huge loss of life and injury to personality. There is a requirement for proper shelter during an emergency. Amphibious structures are one such establishment that is made to live with the flood. Amphibious structures are made of lightweight materials and their base is watertight such that they can handle the compressive force of the building and buoyant force which make them float.

## 2. Design Parameters

1) Hydrostatic load ( $F_{st}$ ): Linearly varying pressure load of floodwater depth. Floating structures will experience hydrostatic force but due to the gravitational force of the structure, the net hydrostatic force is zero. This force is applicable for fixed submerged structures and is calculated by

$$F_{st} = \rho \cdot g \cdot d \quad [Eq1]$$

$\rho$  = Density of floodwater  
 $g$  = Gravity  
 $d$  = Flood water depth

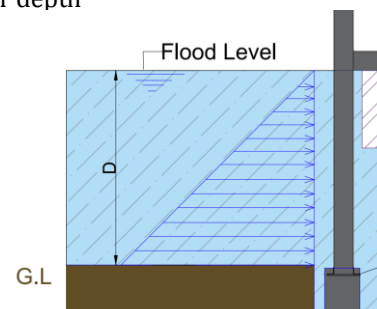

Fig -1: Hydrodynamic Load

2) Hydrodynamic Load ( $F_{dyn}$ ): Force Impacted on a structure due to moving water Velocity

$$F_{D_{yn}} = C_d \cdot \rho \cdot V^2 \cdot A / 2 \quad [Eq2]$$

$C_d$  = Drag Coefficient  
 $\rho$  = Density of floodwater  
 $V$  = Velocity of floodwater  
 $A$  = Area

3) Buoyant Force ( $F_b$ ): It is an Upward force exerted on an object immersed in the fluid.  $F_b$  is equivalent to the weight of the volume of water displaced by an object

$$F_b = W_t \text{ of immersed object} = W_t \text{ the volume of water displaced.}$$

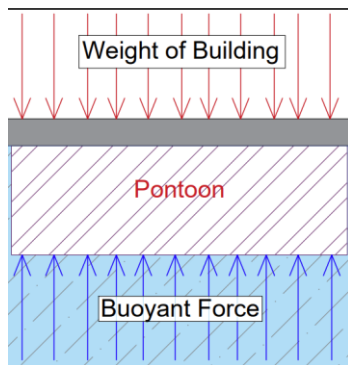

Fig -2: Buoyant force illustration

in Amphibious structures can be restricted by providing jackets. Jackets are designed for horizontal and rotational resultant forces of fluid-structure interaction

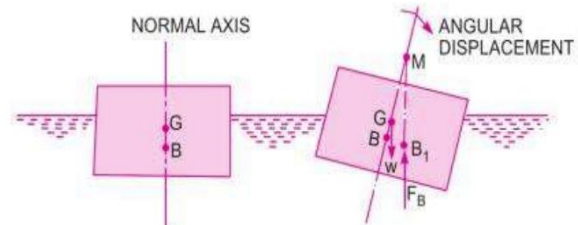

Fig -3: Floating stability (R.K Bansal)

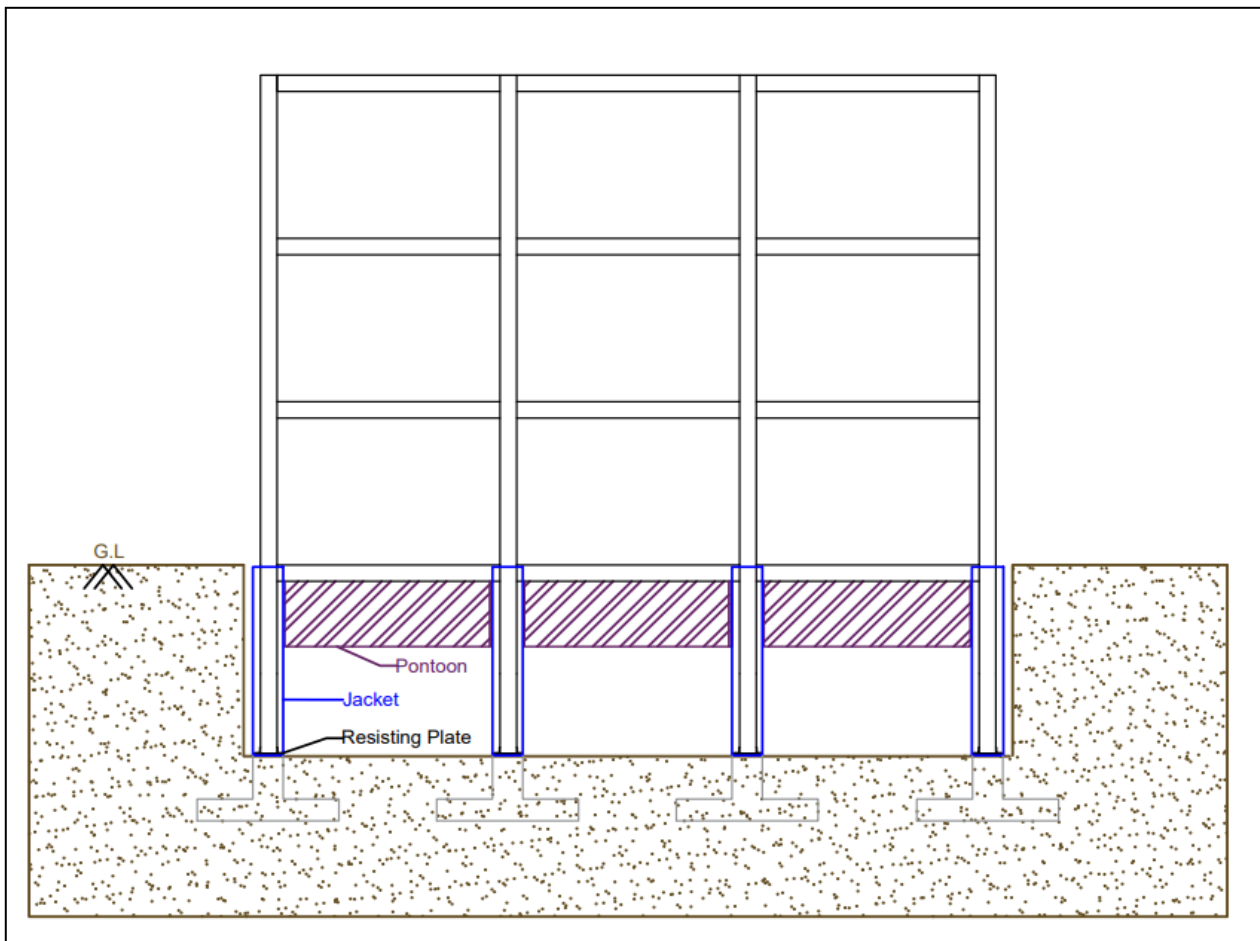

Fig -4: Amphibious structure prior to flooding (not to scale)

Pontoons are compression members which undergo the load of the building as well as buoyancy force. The depth of the pontoon is designed based on volume displaced, the volume displaced is the equivalent weight of the structure.

4) Stability: Floating bodies have a tendency to oscillate when the body is tilted by a small angle. Freedom to oscillate

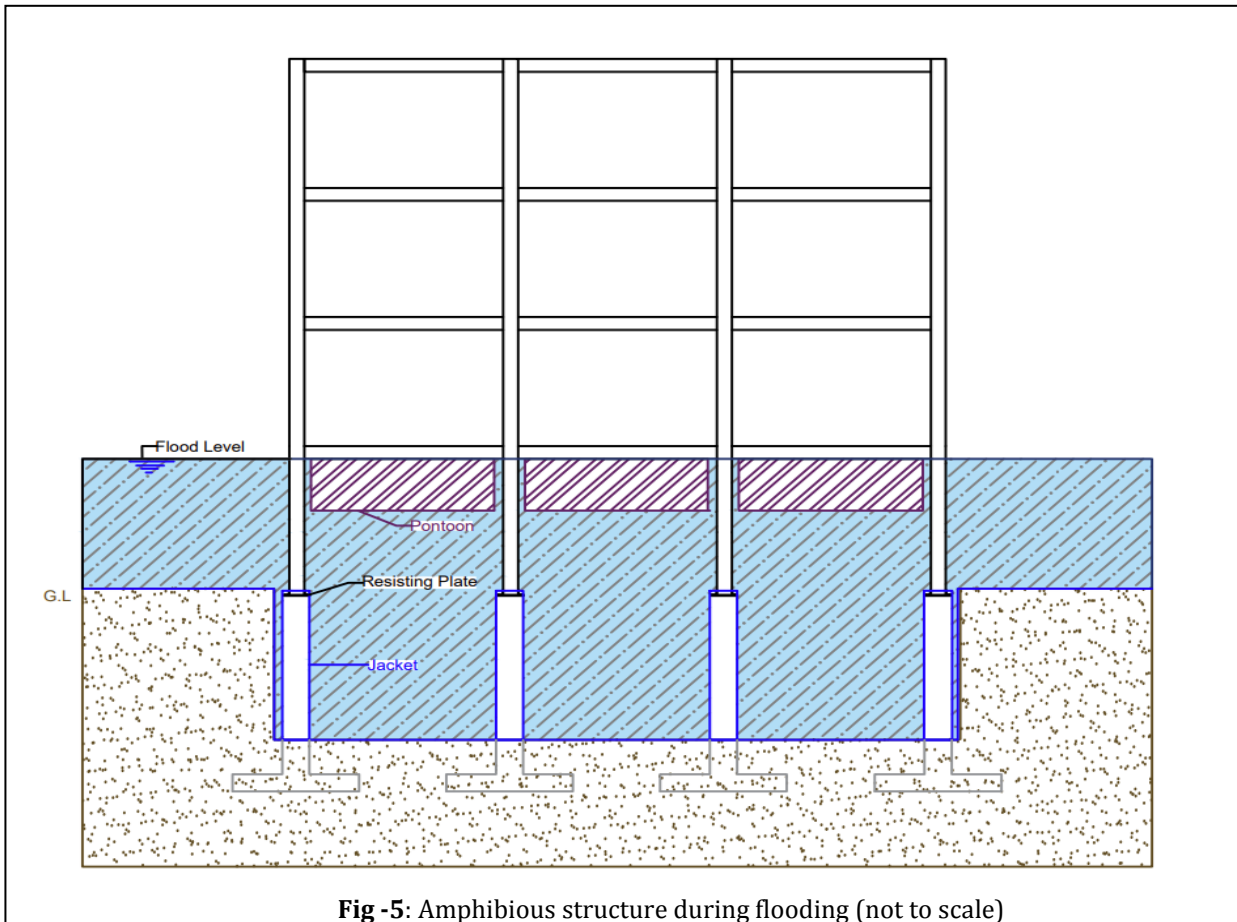

Fig -5: Amphibious structure during flooding (not to scale)

### 3. Methodology

During an emergency such as floods and earthquakes, important buildings play a major role in service. Some of the top tier important buildings are hospitals, fire stations, government buildings, telephone exchange, etc. In this paper, a plan of 3 storey primary health care centre of plot 24.7x 12.7m with a storey height of 3.2m is prepared as per the recommendation of Indian Public Health Standards [Fig. 6]. In order to make the structure light in weight, steel frame is chosen as loadbearing members. For wall surfaces, loads and properties of lightweight concrete sandwiched panels of density 720kg/m<sup>3</sup> is considered.

The design of the building is divided into two main parts superstructure and substructure. The superstructure consists of a building framework (columns and beams) that are modelled and evaluated by load combinations in staad.pro. The substructure consists of pontoons and resisting jackets which are considered as plates and analysed in staad.pro rather than Ansys/Abaqus due to of ease modification and optimization. Lastly, a simplified model of a pontoon with the applied load of the superstructure is tested to float in Abaqus.

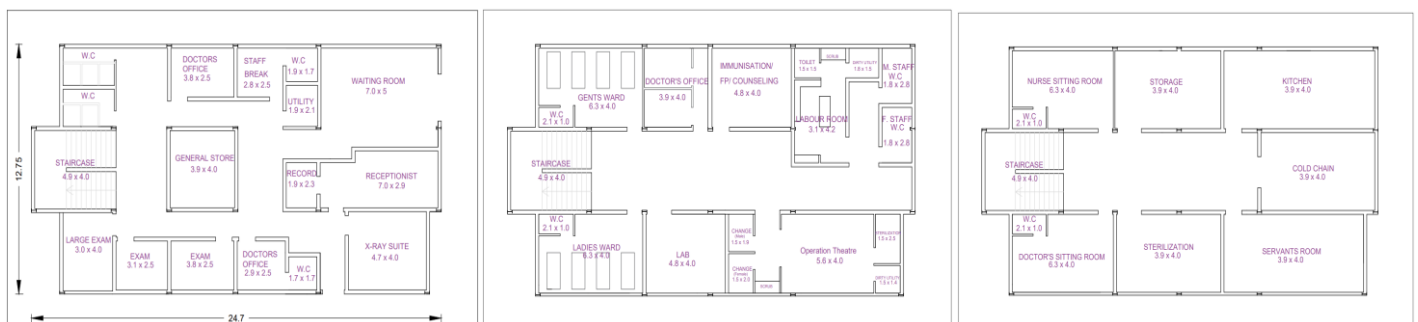

Fig -6: Plan layout of Primary Health Care Centre

### 3.1 Superstructure design

Assumption and load parameters applied for the structure is listed below:

- Considering floodwater depth as 3m and flood velocity of 0.5m/s.
- The hydrodynamic force from [Eq 2] is 5kn/m
- Live load of 3kn/m<sup>2</sup>
- Wall load 2kn/m
- Earthquake Characteristic as per IS 1893

- 1.5DL-1.5EQZ+1.5WL
- 1.2DL+1.2LL+1.2EQX+1.2WL
- 1.2DL+1.2LL-1.2EQX+1.2WL
- 1.2DL+1.2LL-1.2EQZ+1.2WL
- 1.2DL+1.2LL+1.2EQZ+1.2WL

ISMB 300 member was chosen for all the members of the building. Results are evaluated based on the Utilization ratio. The utilization ratio is the ratio of allowable to maximum strength of members. A Member is failed if the utilization ratio is >1. All the values of members do not exceed the value of 1 hence they can satisfactorily take up the loads. Fig 7 is the utilization ratio of the structure that includes the dead load of the pontoon and the load parameters listed.

Zone	2
Response Reduction Factor	3
Importance factor	1.5
Soil	Hard

#### Combinations used

- 1.5DL+1.5LL+1.5WL
- 1DL+1LL+1EQX+1WL
- 1.5DL+1.5EQX+1.5WL
- 1.5DL-1.5EQX+1.5WL
- 1.5DL+1.5EQZ+1.5WL

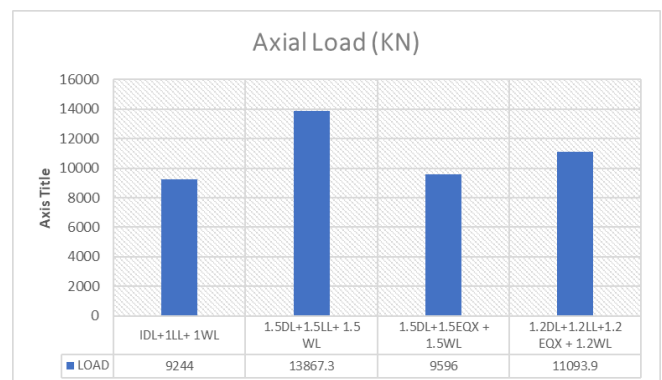

Chart -1: Axial load of Superstructure subjected to different Combinations

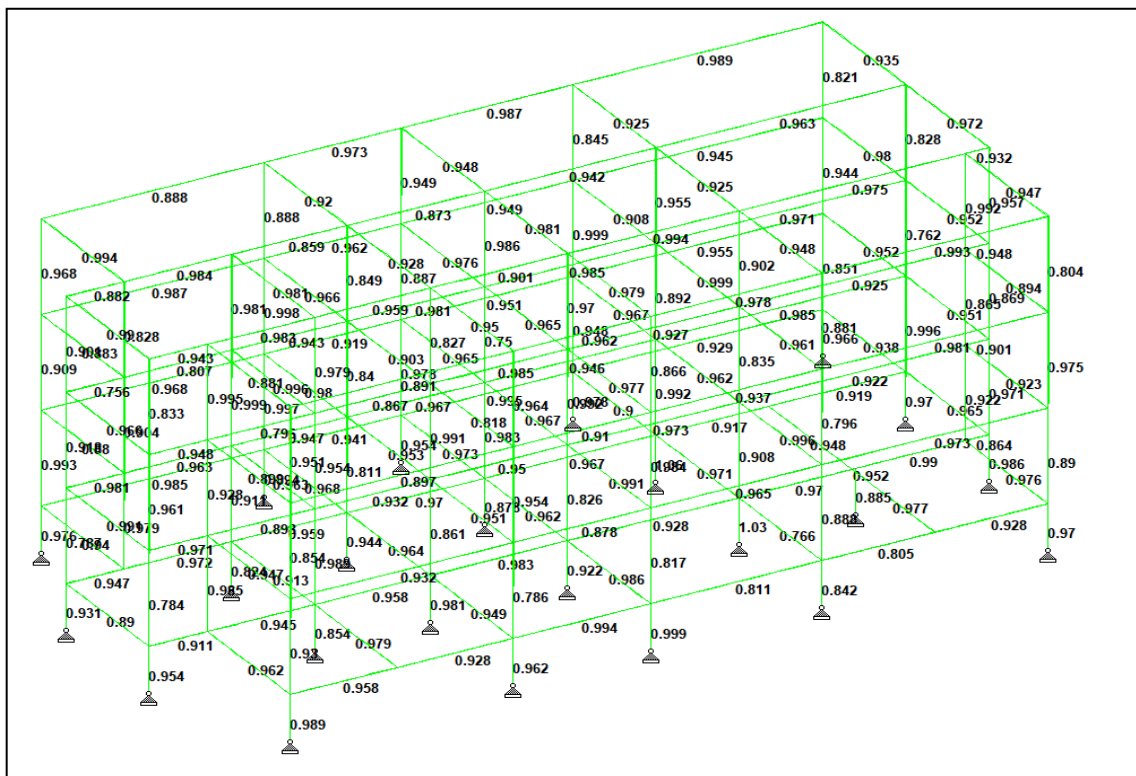
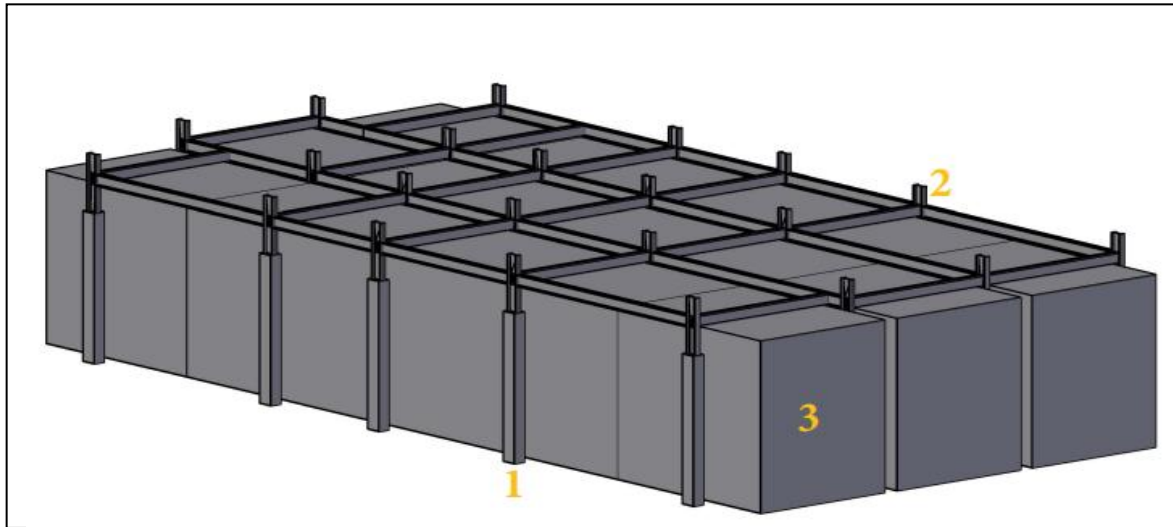

Fig -7: Staad.pro Results (Utilization ratio)

### 3.2 Substructure Design



**Fig -8:** 3D Model of substructure, 1. Resting jacket, 2. Superstructure frame, 3. Pontoon (Deck1)

Both Pontoon and Jacket were designed in staad.pro due to its ease of modification. When a pontoon failed to achieve strength requirements, It is easy to change the thickness or increase the dimensions of the model using Staad.pro. Whereas in Ansys/Abaqus the model needed to be resketched and meshing was a huge concern since the auto mesh wouldn't work even with tet mesh. In order to mesh the model, a partition needed to be created at every end.

#### 3.21 Pontoon Design

Pontoons are compression members which are provided to displace more water to make the structure afloat. 3 Pontoons namely deck 1,2,3 are provided in the structure

i. Pontoon Depth: Total axial load on deck 1 is 3080kn,

self-weight of deck1 is 890kn and the total weight is 3970kn

Volume = Force/ Density of water

Volume=404.68m<sup>3</sup>

Depth = Volume / (B x D)

Total Depth= 4.0m+0.6m (Freeboard) = 4.6m

ii. Structural Properties

Pontoon is designed to withstand a compressive force of 35 kn/m<sup>2</sup>. The thickness of the pontoon is optimized for 24mm. Steel pontoon is used for the design with yield strength, the ultimate strength of 250 N/mm<sup>2</sup> and 420n/mm<sup>2</sup>. Wherever the superstructure beams were run, vertical supports were given in the pontoons to reduce stress For floating objects, the hydrostatic forces are considered to be zero and hydrodynamic load [eq 2] of 5kn/m is applied.

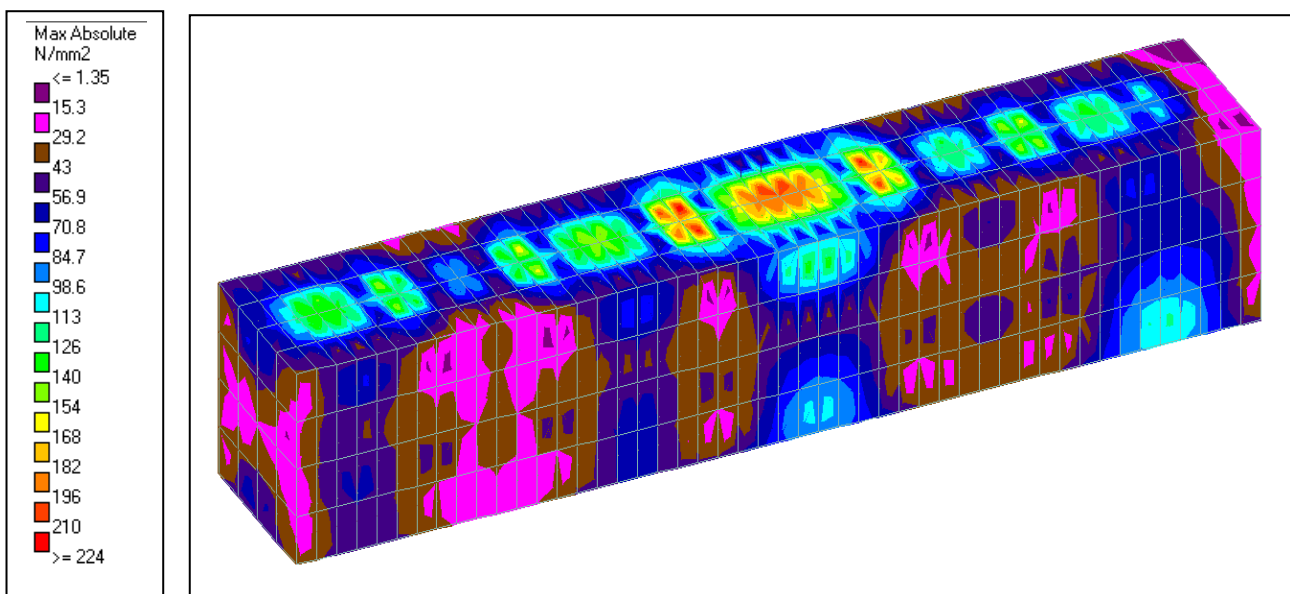

**Fig -9:** Max Absolute Stress diagram of pontoon subjected to loads (Deck1)

### 3.22 Resisting Jacket

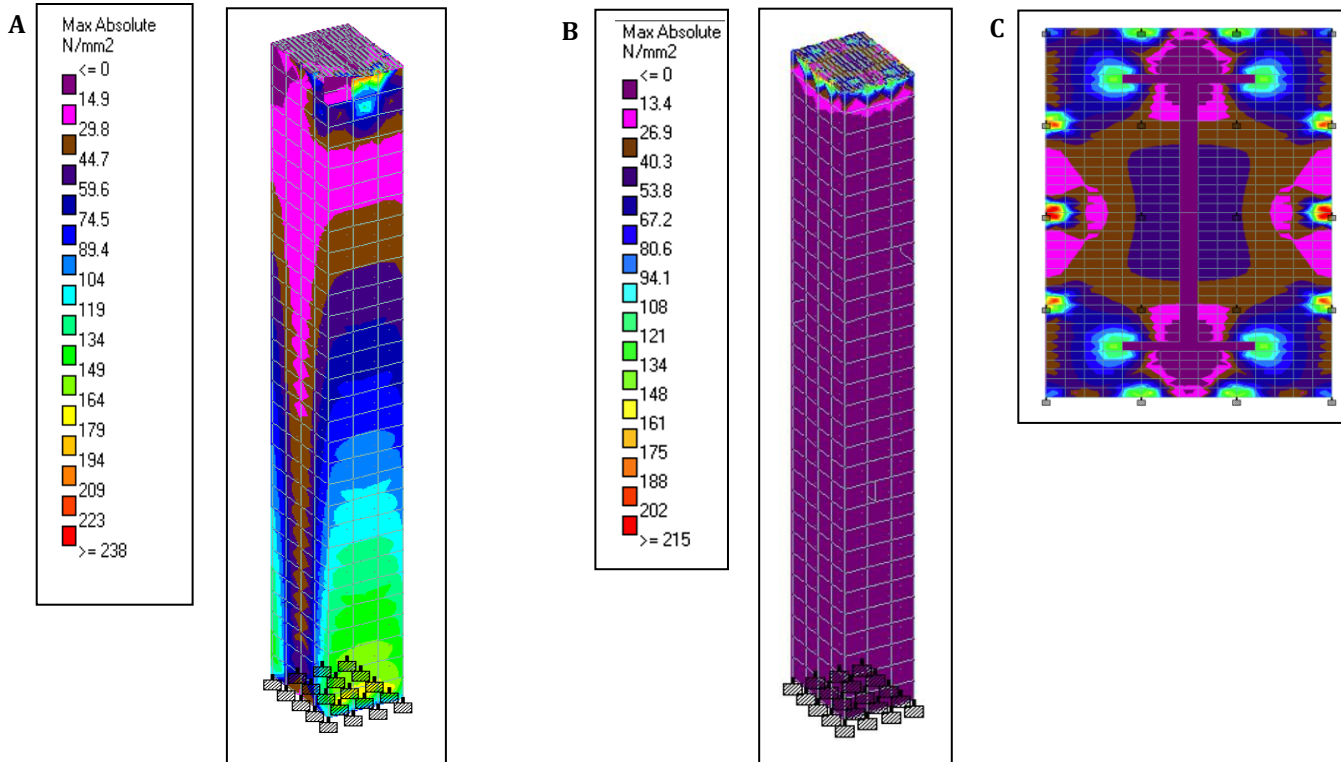

**Fig -10:** Max Absolute Stress diagram of resisting jacket Subjected to A] Case 1, [B] Case 2 and [c] Top view of case 2

The purpose of the resisting jacket is to guide the superstructure from moving away and restrict the rotational movement of the structure due to dynamic forces. This Jacket will stay completely submerged in case of a flood. A drain plug may be required in case of any sand particles setting in the bottom. The resisting jacket is designed with a steel plate of thickness of 17mm and yield strength, the ultimate strength of 250N/mm<sup>2</sup>, 420N/mm<sup>2</sup>. Case 1 (fig13 ) is a stress diagram of a jacket subjected to a load of 160kn at the 3m end. Case 2 (fig14) is a stress diagram caused by the upward pressure of the building to the top jacket plate.

### 4. Floatation test

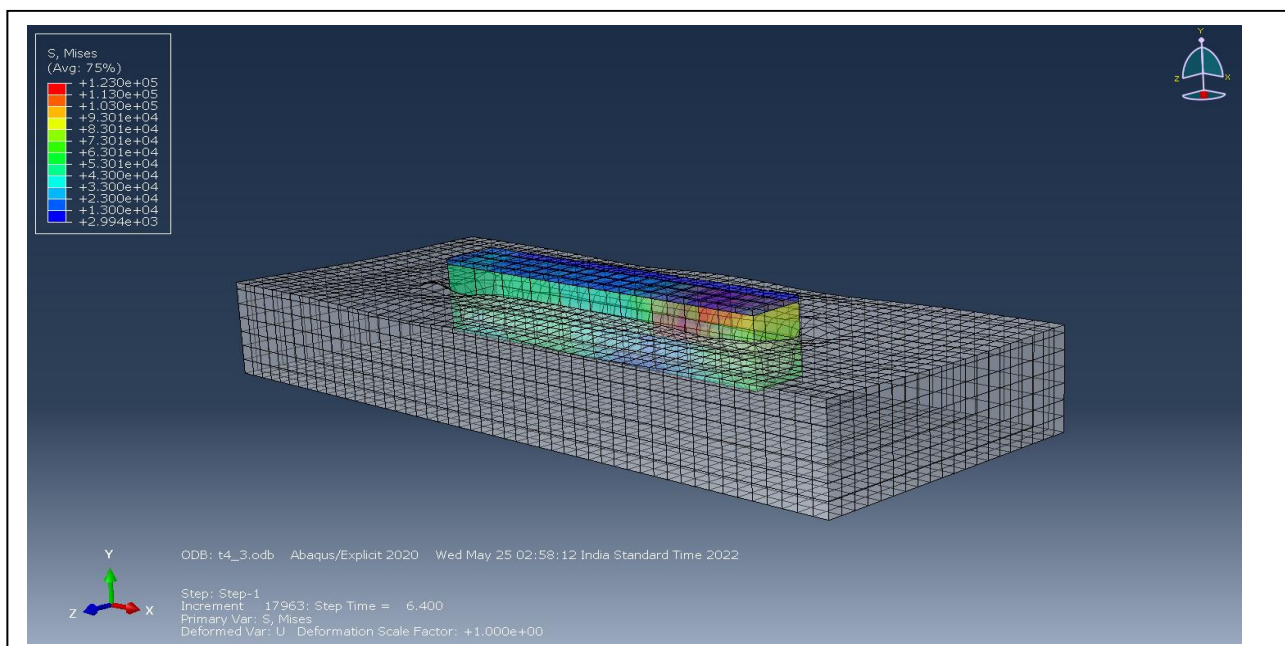

**Fig -11:** Floatation test of simplified model in Abaqus

The floatation test is performed in Abaqus to verify the manual calculations and staad.pro results. The 3D geometry was made using AutoCAD 3d and imported to Abaqus as a ACIS file type. Property and material assignment are made similar to properties assigned in staad. General explicit solver was used to perform the analysis. The Assembly of the model consisted of a base eulerian part (water) with dimensions of 30x50x12m out of which 6m of height was considered as void. Pontoon is placed in the middle of the model as dropped onto the eulerian part. An overlay material was used to apply the load of the structure on the pontoon. Fig11 shows the successful floatation of the model.

### 5. Fluid Interaction

In the case of designing structures for dynamic wave conditions, fig12 shows the fluid-structure interaction of pontoon. This figure is presented in a book written by Subrata k. Chakrabarti on 'Handbook of Offshore Engineering', Volume 1

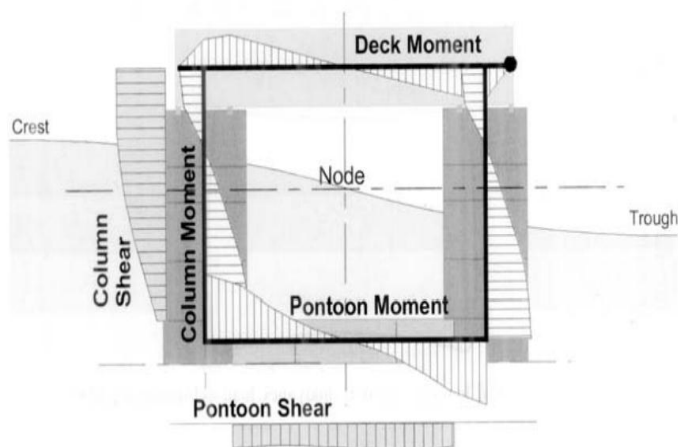

Fig -12: Shear and moment of pontoon subjected to wave (Subrata k. Chakrabarti)



Fig -13: Gravity/Buoyancy deformation pattern of pontoon (Subrata k. Chakrabarti)

### 6. CONCLUSIONS

The amphibious requires precise structural calculation for the functioning of elements. In this paper, a pontoon based amphibious structure was simplified into finer parts and designed. Load on the pontoon was considered based on a combination of 1DL+1LL+1WL and adding a freeboard depth of 0.6m for the design of depth. Considering other combinations would make the structure inefficient.

The pontoon depth required for 3 storey structure was found to be 4.6m which is quite uneconomical. A pontoon-based structure must be constructed only if its required depth is 2m i.e. a single-storey structure. For pontoon depth, greater than 2m providing a watertight sub storey would serve as an efficient design. Further research needs to be conducted on making amphibious structures containing watertight sub storey, utilization of sustainable materials and design of flexible MEP elements. For advanced design considering wave slam, debris impact, dynamic wave impact would make this structure prepared for any floods to come.

The evolution of amphibious houses would serve a great purpose for society. The applications can extend to a town planned amphibious system that can withstand 1 in 500-year floods.

### REFERENCES

- [1] Chakrabarti, Subrata. Handbook of Offshore Engineering (1-volume set). Elsevier, 2005.
- [2] Bansal, R. K. A textbook of fluid mechanics. Firewall Media, 2005.
- [3] FEMA 55 (2011) Coastal Construction Manual: Principles and Practices of Planning, Siting, Designing, Constructing, and Maintaining Residential Buildings in Coastal Areas (4th edn). Washington, DC: Federal Emergency Management Agency.
- [4] Wang, C. M., and B. T. Wang. "Large floating structures." Ocean Engineering & Oceanography 3 (2015).
- [5] Elizabeth C. English, Meiyi Chen, Rebecca Zarins, Poorna Patange & Jeana C. Wisner (2021) Building Resilience through Flood Risk Reduction: The Benefits of Amphibious Foundation Retrofits to Heritage Structures, International Journal of Architectural Heritage, 15:7, 976984, DOI: 10.1080/15583058.2019.1695154
- [6] Mohammad Ali Nekooie, Mohamad Ibrahim Mohamad & Zulhilmil Ismail (2017) Drag coefficient for amphibious house, Urban Water Journal, 14:10, 1045-1057, DOI: 10.1080/1573062X.2017.1325914

- [7] Thriving with water: Developments in amphibious architecture in North America Elizabeth English, Natasha Klink , and Scott Turner E3S Web Conf., 7 (2016)13009;DOI: <https://doi.org/10.1051/e3sconf/20160713009>
- [8] Nilubon, Polpat & Veerbeek, William & Zevenbergen, Chris. (2016). Amphibious Architecture and Design: A Catalyst of Opportunistic Adaptation? – Case Study Bangkok. *Procedia - Social and Behavioral Sciences*. 216.
- [9] Sumantha, Snehanjali, and Elizabeth Englishb. "A Loss Avoidance Study of Amphibious Housing." In *International Conference on Amphibious Architecture, Design and Engineering*. 2015.
- [10] Mohamad, Mohamad & Nekooie, Mohammad Ali & Ismail, Zuhilmi & Taherkhani, Roohollah. (2012). Amphibious Urbanization as a Sustainable Flood Mitigation Strategy in South-East Asia. *Advanced Materials Research*. 622-623. 1696-1700. 10.4028/www.scientific.net/AMR.622-623.1696.
- [11] Norberto C. Nadal and Raúl E. Zapata and Ismael Pagán and Ricardo López and Jairo Agudelo (2010) Building Damage due to Riverine and Coastal Floods; [9] *Journal of Water Resources Planning and Management* 136-3.327-336; DOI: 10.1061/(ASCE)WR.1943-5452.0000036
- [12] Sumayya R K, Prof. Vishal B V, Prof. Mamatha P G, & Prof. Shiva Shankar K M (2021). Analysis, Design And Performance Evaluation Of Floating Building Using Fea, *International Research Journal of Engineering and Technology*, Volume:8, Issue:8
- [13] Manual, Abaqus Scripting User'S. "Abaqus 6.11." <http://130.149.89>, no. 2080 (2012): v6.
- [14] Pike, Kenton, Gang Duan, Jason Sun, and Paul Jukes. "Comprehensive FEA of thermal mitigation buoyancy module (TBM)-soil interaction using the coupled Eulerian-Lagrangian (CEL) method." In *International Conference on Offshore Mechanics and Arctic Engineering*, vol. 49132, pp. 865-870. 2010.
- [15] Aleyaasin, Majid. "An elementary finite element exercise to stimulate computational thinking in engineering education." *Computer Applications in Engineering Education* 30, no. 1 (2022): 31-41.