

# MEDICAL CHATBOT FOR PERINATAL WOMEN USING MACHINE LEARNING

Mr. Venkateshwara A<sup>1</sup>, Aishwarya Rego<sup>2</sup>, Arpita<sup>3</sup>, Disha TM<sup>4</sup>, Raghavnedra B<sup>5</sup>

<sup>1</sup>Department of CSE, BITM Ballari

<sup>2,3,4</sup>Student Department of CSE, BITM Ballari

\*\*\*

**ABSTRACT** – A perinatal woman needs routine examinations and analyses of her medical care. Hospitals are the sole setting where perinatal women can receive medical evaluations, diagnosis, and treatment recommendations. Every woman in the world engages in this. Women consider it to be the most trustworthy method for assessing their health. This technique is being presented as an alternative to going to the hospital and getting a diagnosis from a doctor. The goal of this experiment is to build a chatbot application for pregnant women by combining the concepts of machine learning and natural language processing. Through the series, the perinatal ladies are permitted to interact with a chatbot in a manner similar to how they would with a real person.

**KEY WORDS:** Medical Chatbot, Perinatal Women, Fetal Health Status.

## 1. INTRODUCTION

When everyone in a society is healthy, both the environment and the people are wealthy. If one wants to be happy, it's necessary to keep their bodies and minds in good shape. According to the most recent news from TOI, women find it time-consuming to undergo daily check-ups at hospitals. We have devised a system that offers perinatal women medical help in order to make this easier. It communicates through a chatbot. The chatbot can be used by perinatal women to discuss their symptoms and difficulties. The chatbot offers the user medical aid after recognising patterns in the user's medical data.

Medical chatbots must answer questions from their users with information based on scientific facts. The foetal health model is used to examine and forecast risk throughout pregnancy for physiological variables including blood pressure, blood glucose level, and weight whose variations during pregnancy might lead to issues that can be diagnosed and prevent subsequent complications generated by these changes. A smart system is created to assist expectant moms at various phases of their pregnancy in light of the aforementioned conditions in developing nations. The suggested hybrid strategy provides risk projections based on values of a collection of physiological indicators received from pregnant women,

giving them the chance to regulate, manage, maintain, and avoid likely serious health issues, so providing pregnant women with self-health case services using a machine learning algorithm and a database that stores the mother's days.

The goal of the project is to make it simple for users to communicate with healthcare professionals by responding quickly to their questions. Instead of looking through a list of potentially relevant documents on the web, creating question and answer forums is crucial for responding to those inquiries. Using tongue processing, this method enables computer-human communication (NLP). A chatbot is an entity that imitates human conversation in its specific acceptable setting in conjunction with a written or spoken language using techniques like natural language processing. Semantic understanding uses knowledge of word meaning. The chatbot system communicates with the user by monitoring the status of the conversation and recalling previous requests to provide functionality. They are created using computer algorithms that scan user requests, examine them, and respond to similar queries. The system responds by using a powerful graphical user interface that makes it appear as though a real person is speaking with the user.

## 2. LITERATURE SURVEY

The authors of [1] are Swanthana Susan Alex, Sandra Varghese, Sera Elsa Joy, and Rohit Binu Methew (2019). In order to develop a chatbot application, this study will combine the ideas of machine learning and natural language processing. Medical chatbot for perinatal women utilising machine learning can be very helpful to people in conducting daily check-ups, making people aware of their health state, and encouraging people to take correct actions to be healthy.

The authors of [2] MD Moshir Rehman, Md. Nazmul Khan Liton, and Nahid Hossain (2019). In this research, we present Disha, a machine learning-based chatbot for Bangla healthcare that can communicate in bangla with the aid of its knowledge base by picking up on user interactions.

The [3] authors Nishanth Singh and Prakhar Srivastav (2020). This establishes that a medical chatbot may offer patients a moderately accurate diagnosis with straightforward symptoms analysis and a conventional technique; this suggests that a successful spoken language medical bot may be feasible.

Authors of [4] include Yuan Liao, Ruyi Wang, Giankun Wang, and Ginyu Wang (2020). The author of this article suggests using a chatbot to keep tabs on and evaluate the health of pregnant women. In order to develop a model that predicts the levels of anxiety and depression in perinatal women, this article analyses 31 variables of 233 samples using supervised machine learning.

Mohammed Waseem, Ashfaque, Sumegh Tharewal, Sohail Iqbal, and Charansing N.ktye are the authors of [5]. (2020). This essay intends to conduct a survey of the crucial and essential techniques employed by these conversational and communicational agents.

The [6] Thushar Tanmay, Akanksha Bharadwaj, and Shilpi Sharma author (2020). The medibot, a new chatbot concept proposed in this research, will evaluate users' medical needs. The combination of different artificial intelligence models will enable this chatbot to perform a variety of tasks.

The [7] authors Roop Chandrika, Mallele, Reddy Lakshmi Bhavani, and B. AnkayaRknni (2021). This essay provides a thorough description of how to identify diseases based on their symptoms, enabling the reader to seek medical attention promptly and maintain good health.

The authors of [8] are Nikitha Vijay Shinde, Anikhet Akhade, Pranalli Baged, Harshit Bhavsar, S.K. Wagh, and Amolkamble (2021). In order to answer simple questions about basic health metrics without visiting a doctor, this study introduces a healthcare chatbot that uses artificial intelligence.

The authors of [9] Sagar Badlani, Sheetal Chaudhari, Tanvi Aditya, and Meet Dave (2021). A multilingual health care chatbot application that can diagnose diseases based on user symptoms is described in this study.

The author of [10] Reuben Crasto, Lance Dias, Dominic Mirandi, and Deepali Kayande (2021). With this approach, students would be given access to a chatbot that would

offer the necessary support in a manner akin to that of a counsellor or therapist.

### 3. IMPLEMENTATION:

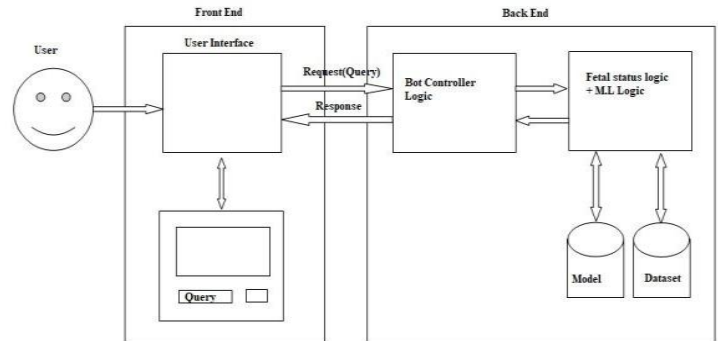

Figure 3.1 : Block Diagram

- **Registration Module:** The registration module in which user should be registered with the registration details, and login to chatbot with user name and password.
- **Fetal Status Prediction Module:** Data set is imported. Processing of the dataset is done. Then the dataset is trained using algorithms and a model is obtained. The model detects and predicts the risk levels during pregnancy.
- **Chatbot Module:** The Perinatal women can ask the questions regarding their symptoms in the automated chatbot and receives response accordingly.

### 4.RESULT AND DISCUSSION

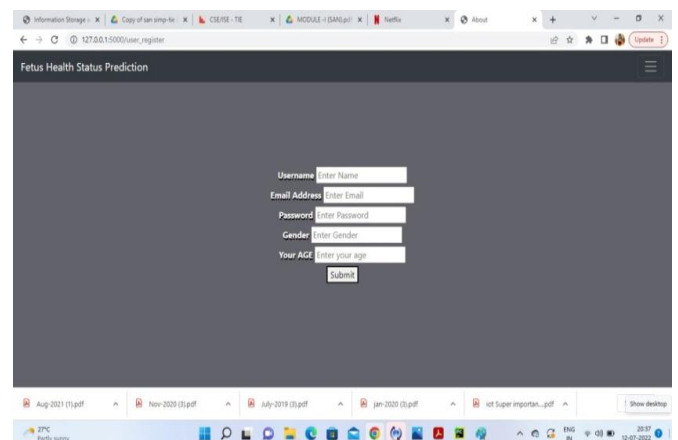

Figure 4.1: The login page

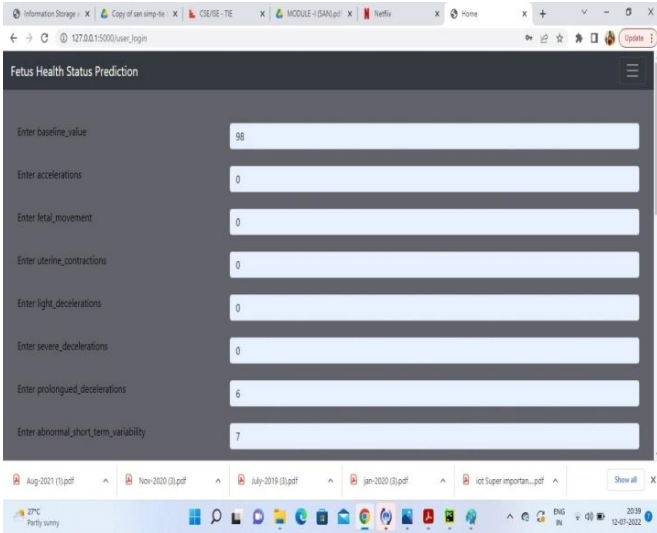

Fig. 4.2: Fetal condition

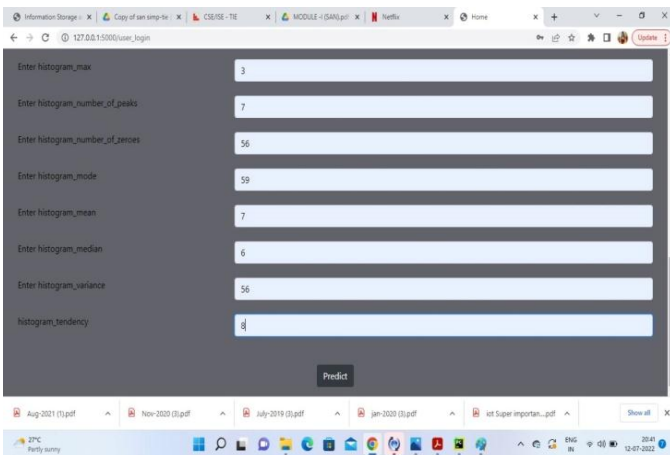

Fig 4.3: Fetal status

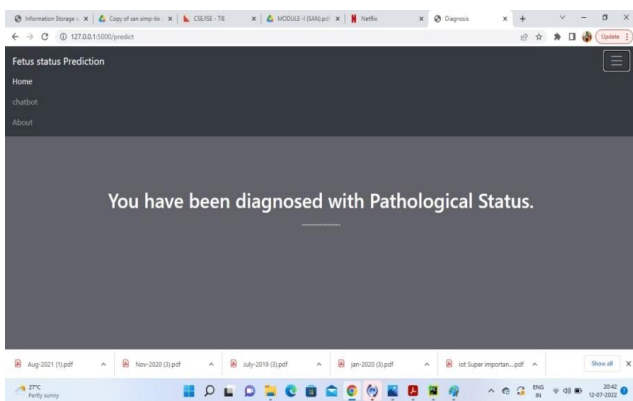

Fig 4.4: Fetal prediction

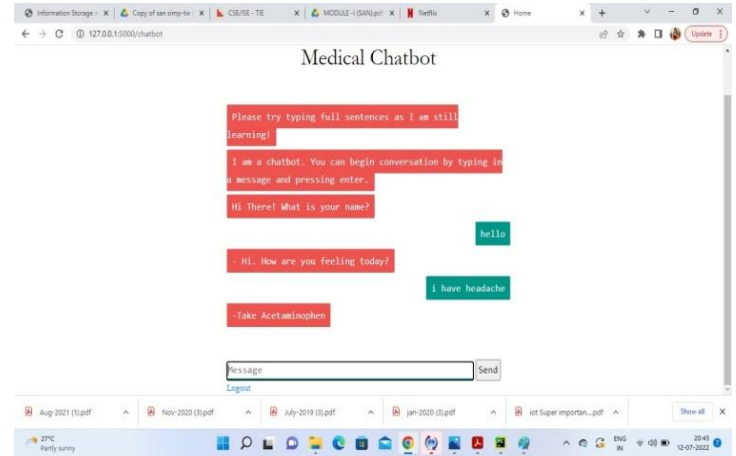

Fig 4.5: Medical chatbot

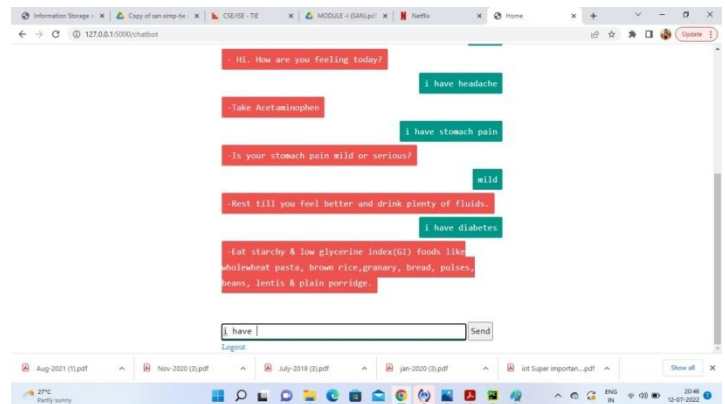

Fig 4.6: Medical chatbot

## 5. CONCLUSION

The medical chat bot provides medical service to the problems faced by perinatal woman. This system predicts the fetal health. During this widespread pandemic, this system proposes an assistance for perinatal women by providing medical solution as it is difficult to travel to the hospital.

## 6. REFERENCES

- [1] R. B. Mathew, S. Varghese, S. E. Joy and S. S. Alex, "Chatbot for Disease Prediction and Treatment Recommendation using Machine Learning," 2019 3<sup>rd</sup> International Conference on Trends in Electronics and Informatics (ICOEI) , 2019, PP. 851-856, doi:10.1109/ICOEL.2019.8862707

- [2] M. M. Rahman, R. Amin, M. N. Khan Liton and N. Hossain. "Disha: An Implementation of Machine Learning Based Bangla Healthcare Chatbot", 2019 22<sup>nd</sup> International Conference on Computer and Information Technology (ICCIT) 2019, PP. 1-6, doi:10.1109/ICCIT48885.2019.9038579
- [3] P.Srivastava and N. Singh,"Automatized Medical Chatbot (Medibot)."2020 International conference on power electronics & IOT Applications in Renewable Energy and its Control(PARC),2020,PP.351-354,DOI:10.1109/PARC49193.2020.236624
- [4] R.Wang,J.Wang,Y.Liao and J.Wang,"Supervised Machine Learning Chatbots for Perinatal MentalHealthcare."2020InternationalConferenceonIntelligentComputingandHuman-ComputerInteraction(ICHCI),2020,PP.378-383,doi.1109/ICHCI151889.2020.00086
- [5] M.W.Ashfaque, S.Tharewal,s.Iqbal and C.N.Kayte," A Review on Techniques Characteristics and approaches of an intelligent tutoring chatbot system," 2020 International conference on smart Innovation in Design,Environment,Management, Planning and Computing(ICSIDEMPC),2020,pp.258-262,doi:10.1109/ICSIDEMPC49020.2020.9299583
- [6] T.Tanmay,A.Bhardwaj and S.Sharma,"E-Health Bot to change the Face of Medicare,"2020 Research,Innovation, Knowledge Mangement and Technology Application for Business Sustainability(INBUSH),2020,pp.49-54,doi:10.1109/INBUSH46973.2020.9392125.
- [7] R.C.Mallela,R.L.BhavaniandB.Ankayarkanni,"Disease PredictionUsingMachineLearningTechniques," 2021 5<sup>th</sup> International conference on Trends in Electronics and Informatics(ICOEI),2021,pp.962-966,doi:10.1109/ICOEI151242.20219453078.
- [8] N.V.Shinde , A. Akhade, P. Bagad, H. Bhavsar, S.K. WaghandaA.Kamble,"HealthCare Chatbot System using Artificial Intelligence",2021 5<sup>th</sup> International Conference on Trends in Electronics and Informatics(ICOEI),2021,pp.1-8,doi:10.1109/ICOEI151242.2021.9452902
- [9] S.Badlani,T.Aditya,M.DaveandS.Chaudhari,"Multilingual Healthcare Chatbot UsingMachine Learning ,'2021 2<sup>nd</sup> International Conference for Emerging Technology (INCET),2021,pp/1-6,doi:10.1109/INCET51464.2021.9456304
- [10] R. Crasto. L.Dias,D.MirandaandD. Kayande, "CareBot:AMental Health ChatBot, "20212<sup>nd</sup> International Conference for Emerging Technology (INCET),, 2021, pp. 1-5, doi:10.1109/INCET51464.2021.9456326.